

Guidelines for PV Power Measurement in Industry

Compiled by partners in the Performance FP6 Integrated Project

PERFORMANCE



The Institute for Energy's mission is to provide support to Community policies related to both nuclear and non-nuclear energy in order to ensure sustainable, secure and efficient energy production, distribution and use.

European Commission
Joint Research Centre
Institute for Energy

Contact information

Address:

via Enrico Fermi 2749,
21027 Ispra,
Italy

E-mail: nigel.taylor@ec.europa.eu

Tel.: +39-0332-783604

<http://ie.jrc.ec.europa.eu/>

<http://www.jrc.ec.europa.eu/>



Guidelines for PV Power Measurement in Industry

Compiled by the European Commission Joint Research Centre, together
with its partners in the PERFORMANCE FP6 Integrated Project, Sub-Project 1:
«Traceable Performance Measurements of PV Devices»

April 2010

EUR 24359 EN

Legal Notice

Neither the European Commission nor any person acting on behalf of the Commission is responsible for the use which might be made of this publication.

This document is provided “as is”. The authors and the PERFORMANCE IP consortium does not provide any warranty of the item whatsoever, whether express, implied, or statutory, including, but not limited to, any warranty of merchantability or fitness for a particular purpose or any warranty that the contents of the item will be error-free. In no respect shall the authors incur any liability for any damages, including, but limited to, direct, indirect, special, or consequential damages arising out of, resulting from, or any way connected to the use of the item.

*Europe Direct is a service to help you find answers
to your questions about the European Union*

Freephone number (*):

00 800 6 7 8 9 10 11

(*) Certain mobile telephone operators do not allow access to 00 800 numbers or these calls may be billed.

More information on the European Union is available on the Internet (<http://europa.eu/>).

Cataloguing data can be found at the end of this publication.

JRC57794

EUR 24359 EN
ISBN 978-92-79-15780-6
ISSN 1018-5593
doi:10.2788/90247

Luxembourg: Office for Official Publications of the European Union

© European Union, 2010

Reproduction is authorised provided the source is acknowledged

Printed in Belgium

PRINTED ON RECYCLED PAPER

Foreword

These guidelines have been compiled by the members of the sub-project 1 of the PERFORMANCE Integrated Project. They represent the culmination of 4 years work from 2006 to 2009, and bring together results of round robin testing, reviews and surveys, as well as the partner organisations' extensive knowledge in this field. The format adopted also reflects the wishes expressed by PV module manufacturers in a survey conducted in 2008/2009. These included:

- ... a clear and detailed guideline which explains a simple, practical and robust procedure for accurate measurements of PV Modules...
- ... how to obtain and conserve a good simulator measurement for a-Si modules, with several possibilities... which procedures have to be undertaken, which documents have to be delivered to avoid traceability issues
- ... useful for PV Industry, especially for newcomers...
- ... guidance indoor and outdoor measurement of thin film modules... need to have a flexible method that works for different CIS modules (different producers, different production technologies).

We hope the sections below address these and other important issues.

On behalf of the key contributors (in alphabetical order):

E. Dunlop, JRC

H. Müllejans, JRC

F. Fabero, Ciemat

A. Virtuani, SUPSI (formerly JRC)

G. Friesen, SUPSI

W. Warta, FhG ISE

W. Herrmann, TÜV Rheinland

W. Zaaiman, JRC

J. Hohl-Ebinger, FhG ISE

S. Zamini, AIT

H-D. Mohring, ZSW

Compiled by N. Taylor, JRC

Contents

1. Introduction.....	9
1.1 Scope.....	9
1.2 Definitions.....	10
1.3 Existing Standards.....	10
2. Survey of Current Practices.....	15
2.1 Solar Simulator and Other Instrumentation.....	16
2.2 Measurement Procedure.....	18
2.3 Data Analysis.....	19
2.4 Reference and Measured PV devices.....	20
2.5 Documentation and Quality.....	21
2.6 Survey Conclusions.....	22
3. Equipment and Basis of Power Measurement.....	23
3.1 Solar simulators: requirements and limitations.....	23
3.2 Reference Devices and Spectral Mismatch Correction.....	27
3.2.1 Main Requirements.....	27
3.2.2 Spectral Mismatch.....	28
3.2.3 Practical Considerations.....	28
3.2.4 Non-Crystalline Silicon Modules.....	30
4. Measurement Procedures.....	31
4.1 Module Measurements on Simulators.....	31
4.1.1 General.....	31
4.1.2 Requirements for Reference Modules.....	32
4.1.3 Choice of Main Parameter for Calibration.....	32
4.1.4 Calibration Procedure.....	33
4.1.5 Module Temperature Measurement.....	33
4.1.6 Quality Assurance.....	34
4.2 Outdoor Measurements.....	35

5. Technology-Specific Issues	37
5.1 High Efficiency Silicon Modules	37
5.1.1 Measurement Equipment	40
5.1.2 Measurement Procedures	41
5.1.3 Back-Contact Devices	45
5.2 Thin Film Modules	46
5.2.1 Solar Simulators	46
5.2.2 Capacitive Effects	47
5.2.3 Pre-Conditioning	47
5.2.4 Reference Devices	50
5.3 Multi-Junction Thin Film Modules	55
5.3.1 Spectral Mismatch	55
5.3.2 Reference devices	57
6. Traceability and Uncertainty	59
6.1 Basic Considerations	59
6.2 Traceability	59
6.3 Measurement Uncertainty	60
6.3.1 Contributing Factors	60
6.3.2 Calculation Principles	62
6.4 Good Practice	63
7. Quality Control and Data Handling	65
7.1 General Measures	65
7.2 Training	65
7.3 Measurement Uncertainties	66
7.4 Data archiving production documentation	66
8. Summary and Recommendations	67
9. References	71

Symbols and Abbreviations

AM	air mass
a-Si	amorphous silicon
BCC	back-contact cell
CdTe	cadmium telluride
CIGS	copper-indium-gallium diselenide
CIS	copper indium diselenide (or sulphide)
CI(G)S	designation covering both CIS and CIGS technologies
c-Si	crystalline silicon
FF	fill factor
HIT	heterojunction with intrinsic thin layer
I_{sc}	short-circuit current
$\mu\text{c-Si}$	micromorphous silicon
MJ	multijunction
MPP	maximum power point
P_{max}	maximum power
PV	photovoltaic(s)
SR	spectral response
STC	standard test conditions
UC	uncertainty
V_{oc}	open-circuit voltage

1. Introduction

1.1 Scope

Energy output for photovoltaic devices is commonly related to the declared Watt peak value, i.e. the electrical performance under standard test conditions (STC): the reliability of this value and its associated uncertainty are of crucial importance to manufacturers, operators and investors. Such measurements are carried out either by industry and dedicated testing laboratories. To be valid, each measurement has to demonstrate an unbroken traceability chain to international primary standards and a calculation of measurement uncertainty for each transfer in the chain. Without either of the two, the measurement is purely indicative and has no legal value i.e. it would not be acceptable in any kind of dispute.

For crystalline silicon modules the industry has levels of uncertainty on maximum power typically ranging from 5 to 10%, while specialised testing laboratories achieve values from 2 to 3%. To put this in economic perspective, every 1% uncertainty on peak power corresponds to a value of over €1bn, assuming a world wide PV production of 38 GW in 2010 and a nominal module price of 3€/ Wp.

The PERFORMANCE Sub-Project 1 was set up to address the issue characterisation of the power output of PV modules, with the following objectives:

- Transparency of traceability chain of indoor module measurements: (a) test labs, (b) industry
- Development of measurement procedures for new and emerging technologies (thin film cells, multi-junction cells, back contact silicon cells, etc.)
- Improvement/harmonisation of precision and comparability of characterisation results
- 5% tolerance for output power labelling of PV modules in industry

These guidelines directly address these objectives and aim to provide practical information on best practices for implementing the requirements laid down in the existing international testing standards and for characterising emerging PV technologies for which as yet no standards exist. The work brings together the work of all four work packages in SP1, as well as reflecting the extensive expertise and experience of the laboratories and organisations involved.

Before addressing the technical issues which are at the core of these guidelines, the following three sections consider a) definitions, b) existing standards in this area and c) the results of a SP1 survey of industrial organisations performing power measurements.

1.2 Definitions

Standard Test Conditions (STC): total irradiance = 1000 Wm^{-2} , device temperature = 25°C , reference spectral irradiance for air mass = 1.5 as defined by IEC 60904-3

Calibration Measurements: this refers exclusively to measurements made by an accredited testing laboratory to determine the absolute power output of a device (P_{max}) at STC. The value obtained can be formally declared on a calibration certificate. To be valid, such measurements must demonstrate an unbroken traceability chain to international primary standards and include a calculation of measurement uncertainty.

Other Measurements: this category covers all measurements other than the P_{max} calibrations and includes:

- power measurements made for comparative purposes e.g. for module qualification
- temperature coefficient and spectral response measurements
- measurements made to support energy rating models

The quality of the data depends on the documented testing procedure and measurement conditions.

Uncertainty: The uncertainty or margin of error of a measurement is stated by giving a range of values including the likelihood to enclose the true value.

Accuracy: the accuracy of a measurement system is the degree of closeness of measurements of a quantity to its actual (true) value.

Repeatability: Repeatability (or precision) is the variation in measurements taken by a single person or instrument on the same item and under the same conditions. A measurement may be said to be repeatable when this variation is smaller than some agreed limit.

Traceability: Traceability requires the establishment of an unbroken chain of comparisons to stated SI references, each with a stated uncertainty.

1.3 Existing Standards

Over the last 29 years the International Electrotechnical Commission (IEC) has developed a comprehensive set of standards in particular for crystalline silicon devices and more recently also for some thin film technologies. There are currently ten standards (9 in the 60904 series and 60891) applicable to the components and processes involved in power measurements. These are transposed into European norms via the European Committee for Electrotechnical Standardization CENELEC and then to national standards, keeping the same number (Fig. 1). Table 1 summarises the available standards relevant to power measurements, following the scheme in Fig. 2.

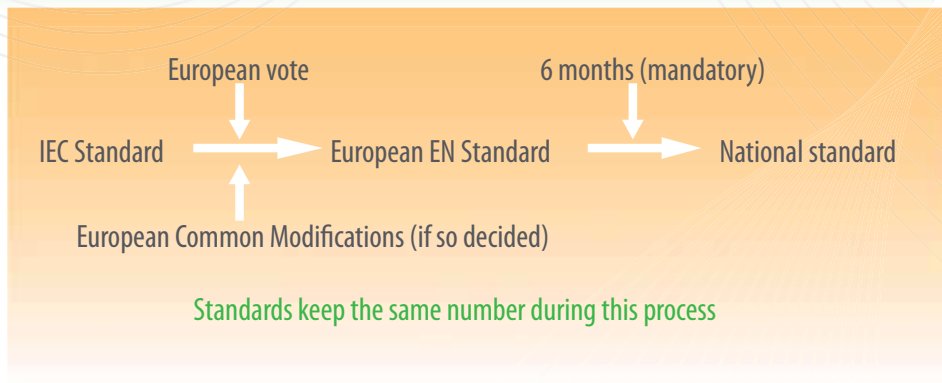

Figure 1: Procedure for the transposition of IEC standards to European and national levels.

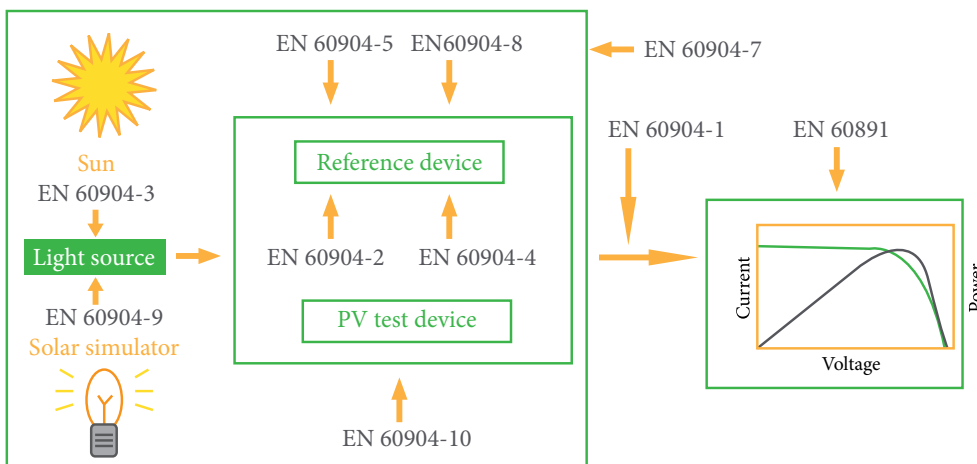

Figure 2: Schematic of the standards relevant to power measurements (the IEC numbers are identical).

Table 1: Standards relevant to PV power measurements

Scope	Applicable EN (IEC) Standards	Notes
Light source	IEC 60904-3 Measurement principles for terrestrial photovoltaic solar devices with reference spectral irradiance data	Defines the standard spectrum for STC
	IEC 60904-9 Solar simulator performance requirements	Defines the characteristics of the solar simulators into classes A, B or C relating to: <ul style="list-style-type: none"> – spectral distribution match – irradiance non uniformity on the test plane – temporal instability (STI and LTI) Measurement procedures for these characteristics are included
Reference devices	IEC 60904-2: Requirements for reference solar devices	Includes selection, construction details and recommended packaging depending on their use
	IEC 60904-4: Procedure for establishing the traceability of the calibration of reference solar devices	Includes different calibration procedures to get traceability to SI units
Test and reference devices	IEC 60904-5: Determination of the equivalent cell temperature (ECT) of photovoltaic (PV) devices by the open-circuit voltage method	Helps solve problem of determination of the temperature of a PV device
	IEC 60904-8: Measurement of the spectral response of a photovoltaic (PV) device	Standard method for the determination of this basic characteristic
	IEC 60904-10: Methods of linearity measurement	Methods for determining the linearity of the electrical characteristics of PV devices vs. irradiance and temperature

Scope	Applicable EN (IEC) Standards	Notes
Light source and PV devices	IEC 60904-7: Computation of the spectral mismatch correction for measurements of photovoltaic devices	Involved in the calculation are: <ul style="list-style-type: none"> – the experimental spectrum of the light source – the standard solar spectrum (EN 60904-3) – the spectral responses (absolute or relative) of both test and reference PV devices
How to measure I-V curves	IEC 60904-1: Measurement of photovoltaic current-voltage characteristics	Standard methods for measuring I-V curves, depending on the light source (natural or simulated: steady-state or pulsed solar simulator)
How to translate I-V curves	IEC 60891: Procedures for temperature and irradiance corrections to measured I-V characteristics of photovoltaic devices	From experimental to targeted irradiance and temperature

2. Survey of Current Practices

To help prepare these guidelines, the SP1 group conducted a survey of industrial practices for PV power measurement. The aim was both to assess current practices and to allow the potential “end-users” to indicate the areas in which guidance could be most beneficial. The questionnaire was divided into 7 parts:

- Solar simulator used
- Other instrumentation
- Measurement Procedure
- Data Analysis
- Reference devices
- PV devices measured
- Documentation and Quality

It was distributed initially in autumn 2008 by EPIA to more than 100 industrial organisations. In addition the SP1 partners made direct contacts. This resulted in 13 completed replies, which cover a wide range of common module types as shown in Fig. 3. Fig. 4 shows the distribution of annual production volumes. The geographical spread included companies based in Germany, Spain and Switzerland. The responses have been analysed and are presented in the following sections to give an overview of current practices. The confidentiality of the participants is respected and no company names are given.

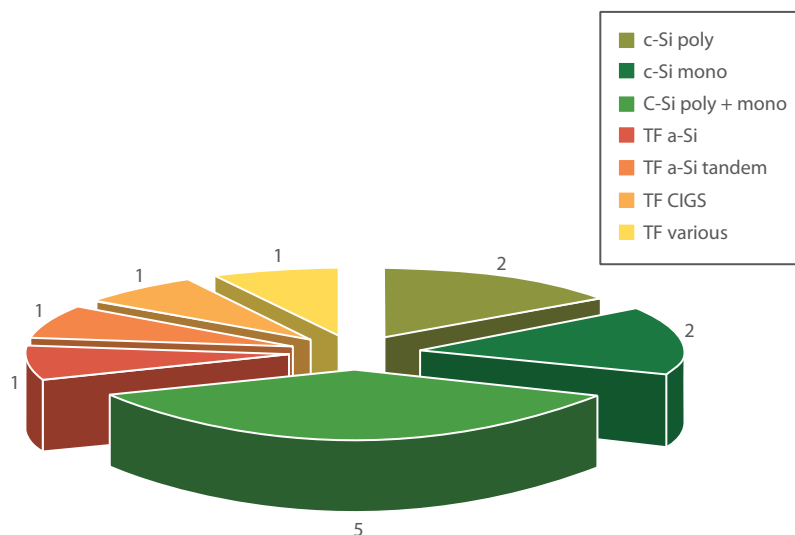

Figure 3: Breakdown of module types covered in the survey of producers.

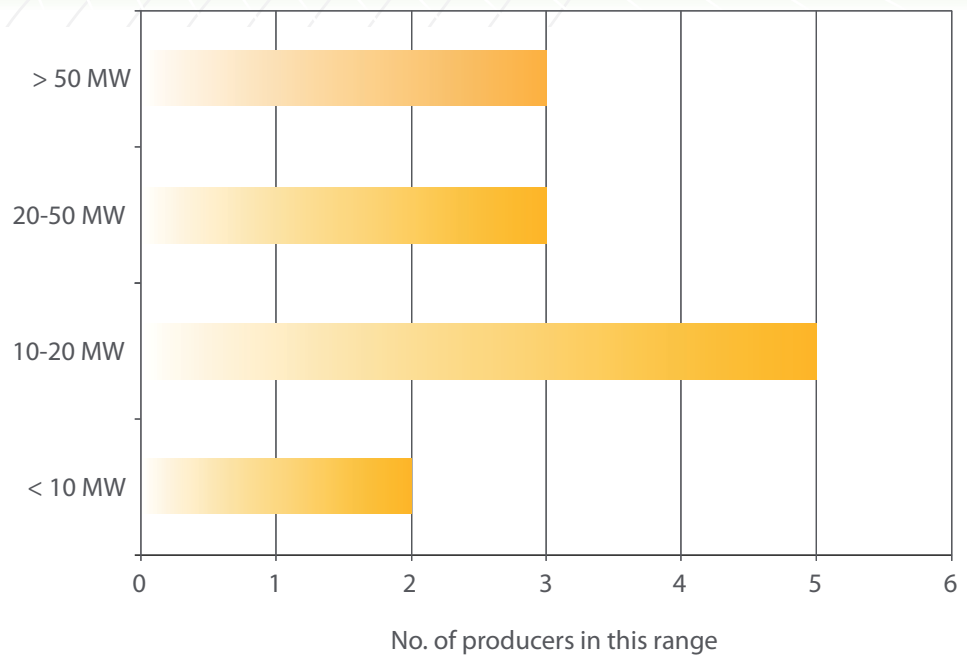

Figure 4 : Annual production volumes of the producers surveyed (2008/2009).

2.1 Solar Simulator and Other Instrumentation

Question	Response
Solar simulator used	5 use Endeas 4 use Berger 2 use Nisshinbo 1 uses Pasan 1 uses Halm
Type of Measurement (Pulsed or Continuous)	All use pulsed (4 specify a decay pulse) 3 use a 2 ms flash 9 use ≥ 10 ms N.B. The hin film producers use pulse times from 10 to 30 ms.
Simulator Classification	Spectral Match: 12 Class A; 1 no indication Non-uniformity: 12 Class A, 1 Class B Temperature stability: 12 Class A, 1 Class B
Measurement Area	9 in range 0.72 to 4 m ² 1 of 7 m ² 3 no answers

Question	Response
Interval of Simulator Classification	8 state yearly 2 "other" 1 "no reply" 2 daily (<i>question misunderstood?</i>)
Loads	9 Electronic 4 Resistive. N.B. None explicitly mentioned 4 quadrant loads (8 one quadrant, 5 no replies)
Connection	All use Kelvin i.e. 4 wire, connection
Temperature sensor	6 PT100 2 LM35 1 Thermometer 1 PT1000 1 Infrared 1 thermocouple 1 unsure between PT100 and PT1000
Data acquisition	10 software from simulator manufacturer 1 own software 2 "no replies"

Comments:

- *"uniformity is checked every 2 weeks; other aspects are checked yearly by external body"*
- *"the measuring device is calibrated every year by the simulator manufacturer and the Deutsche Kalibrierdienst"*
- *"Uniformity is checked in detail during acceptance and then checked weekly roughly; spectrum: not checked; irradiance is checked weekly, but not to class A".*

2.2 Measurement Procedure

Question	Response
Time between lamination and measurement:	1 states 20 s 2 state 3-20 min 6 state "hours" 2 state "days/week"
Declared ambient temperature and accepted range [°C]	10 state 25°C, with a ranges from ± 2 °C to ± 10 °C 1 states $22^\circ\text{C} \pm 2^\circ\text{C}$ 1 states $23^\circ\text{C} \pm 5^\circ\text{C}$
Parameters monitored	
Device Temperature [°C]:	1 states $22^\circ\text{C} \pm 2^\circ\text{C}$ 9 state $25^\circ\text{C} \pm 5^\circ\text{C}$ 1 states $25^\circ\text{C} \pm 10^\circ\text{C}$ 1 states $30^\circ\text{C} \pm 5^\circ\text{C}$
Irradiance [W/m ²):	1 states 930 W/m ² 1 states 990 W/m ² 10 state 1000 W/m ² 1 states 1500 W/m ²
Sweep Technique	All measure the full I-V curve during a single sweep
Sweep Direction	11 state I _{sc} ->V _{oc} 2 no replies
Sweep Duration	5 state 2 ms 5 state 10 ms 1 states 15 ms NB The declared TF producers all state 10 ms
Sweep Data Acquisition	All state I, V, H measured same time, but 5 explicitly state simultaneous recordings

Comments:

- "light soak right before I-V measurement, with a delay of < 1 min".
- "the device temperature depends on ambient temperature".

2.3 Data Analysis

Question	Response
Corrections	All use irradiance correction All use temperature correction Only 2 use spectral correction No common method and in some cases not specified. Methods mentioned: 2 use IEC 60891 for temperature 1 uses the Blässer method for irradiance and temperature correction 1 uses an ESTI sensor 1 uses an "optical assembly"
Basis for the correction	Several mentioned valid sources (TÜV, ASU, JET, FhG-ISE, SUPSI) 1 stated the equipment operating manual 1 stated that it is programmed in the software
Extrapolating for I-V parameters?	4 do extrapolate (1 notes the use of fitting and 1 of proprietary software)
Measurement uncertainty	8 stated "Calculated" 2 stated "Ignored" 3 "no reply"

Comments:

- *"it would be very useful for industry to have a tool or procedure about how to calculate the uncertainty".*
- *"uncertainty ignored at the moment; soon will be included in module classification".*
- *"covered by manufacturing tolerance".*
- *"system calibrated against reference module from an accredited lab; calibration procedure carried out every working shift – the difference in P_{Max} is $< 1\%$ "*

2.4 Reference and Measured PV devices

Question	Response
Reference Devices	
Type	9 stated modules 1 stated cells 3 stated modules and cells N.B. 10 use reference devices of the same type and size as the measured device.
Frequency of Use	Replies included: – Once per shift – After a pre-defined number of flashes (simultaneous recording of H??) – “When necessary” (but no criteria given)
Traceability	Most mentioned a specific accredited laboratory 2 answers were positive did not specify the source
Stabilization	2 state “light exposure” 1 states “as defined in IEC61215” 1 states “outdoor, short circuit, 1 week” 1 states “outdoor, 1 week” 1 states “light soaking 30kW/m ² ” 1 states “outdoor, followed by indoor 1000 W/m ² @ 50°C until delta P _{max} < 2%” 1 states 40 hours partial stab?
Maintenance of contacts	5 “yes” 7 “no” 1 “no reply”
Transfer of calibration factor to other reference device	7 “No” 2 “Yes”, with 2 “no method mentioned” and 1 which stated “based on average I _{sc} of 5 measurements”

Comments:

TF producer: *“At the moment we are only working with a filtered c-si reference cell, which is relatively well adapted to our a-Si module spectrum, and with a-ci ref module to check the daily stability of measurement. Further we have some relative stable a-Si modules, which are stored at the dark and taken out only once a month, but they are not fully stabilized. We are working on a better method”*

Question	Response
Measured Devices	
Storage	Indoors
Stabilisation & Preconditioning	6 "No" 2 "Yes", Light Soak , Outdoor 1 "No, We are looking to go to a good pre-conditioning"
Check for capacitive Effects	9 "no" 1 "yes" (sweeps in both directions for different modules) N.B. The yes is from a TF producer; the other 3 TF producers stated "no".

2.5 Documentation and Quality

Question	Response
Quality System	5 ISO 9001 4 Internal or not specified 1 No
Accredited (yes/no/by whom)	8 "No" 2 "Yes"
Measurement procedures and results	Documented by all
Raw data & system configuration	Documented by all, except 1
Regular calibration of instruments and sensors	11 "yes" 1 "no" 1 "no reply"
Measurement uncertainties documented	5 "yes" 4 "no" 4 "no reply"
All personel trained and qualified	Yes for all, except 1 no reply
Participation to inter-comparisons	6 "yes" 5 "no" 1 "no reply"

Comments

- Measurements instruments and sensors calibrated every 2 years.
- What is a acceptable calibration interval for the instruments?
- We are just going to absolute values from the simulator based on several reference devices measured by an institute. We are going to build up a quality system with validation of reference devices. We want to establish the exact absolute values at our simulator by letting several a-Si reference modules at an institute. They will mainly be stored in the dark, and the daily controls will be done with a c-Si reference module. We then also want to exclude the measurement uncertainty.

2.6 Survey Conclusions

The main issues which emerged are as follows:

- Proper equipment: the classification and calibration of the solar simulator, of reference devices and of other instrumentation e.g. temperature sensors and load, need to be properly checked and controlled.
- Know-how and operational competence in relation to the measurement procedure, data analysis and the PV devices measured; particular areas of concern in this respect are uncertainty handling and checking of connections.
- Adequate documentation and quality assurance.

3. Equipment and Basis of Power Measurement

3.1 Solar simulators: requirements and limitations

Power measurements of PV modules in test laboratories and industry are usually performed with flash-type solar simulators¹ and are often referred to simply as indoor measurements. The advantages of are obvious:

The measurement is not dependent on weather conditions

A high reproducibility is achieved because test conditions can be adjusted to the desired ranges of module temperature and irradiance.

The nominal power of PV modules is defined as the maximum output power under standard test conditions (STC) according to IEC 60904-3. Measuring techniques for solar simulators are, therefore, aiming to measure as close as possible to these conditions. However, solar simulators are not perfect light sources, and the quality of emitted light can strongly influence the result of the power measurement. In particular, the following parameters must be considered:

Effective irradiance

The lamp power of the simulator must be adjustable to give 1 000 W/m² effective irradiance in order to keep the uncertainties from irradiance correction low. Up to now solar simulators have mainly been designed for power measurement of crystalline silicon PV modules. To achieve the same level of effective irradiance for other technologies may require a considerably different lamp power.

Pulse length

The pulse length determines the I-V data acquisition time for power measurements. It is typically in the range of 2 ms to 10 ms. A longer pulse length may be required for some PV technologies to avoid possible transient capacitive effects resulting from high-speed measurement. This applies for example for c-Si modules with high-efficiency cells. Long-pulse and multi-flash measurement techniques are available to address the problem.

Spectral irradiance distribution of the lamp

The response of solar cells is strongly dependent on the wavelength. For solar simulators in PV industry xenon light sources are normally used. The spectral irradiance of this lamp type differs considerably from AM1.5 spectral irradiance. As a result measurement errors may occur if the PV reference device is not spectrally matched to the module to be measured. Moreover, spectral differences will cause so-called current mismatch between junctions in multi-junction PV modules. In such cases filtering methods must be applied in order to reduce measurement errors.

¹ Here the discussion is restricted to flash-type simulators which are typically used for testing modules in industry; nonetheless many of the considerations are equally relevant to steady-state simulators used for characterising cells.

Uniformity of irradiance in the test area

If a PV module is not uniformly illuminated, individual cells will deliver different photocurrents. For series connected cells with high module currents in the range of I_{sc} , cells with lower photocurrent will operate at negative voltage range on its reverse characteristic. This means a negative contribution to module voltage and a deformation of the I-V curve in comparison to the ideal case for uniform irradiation (Figure 5).

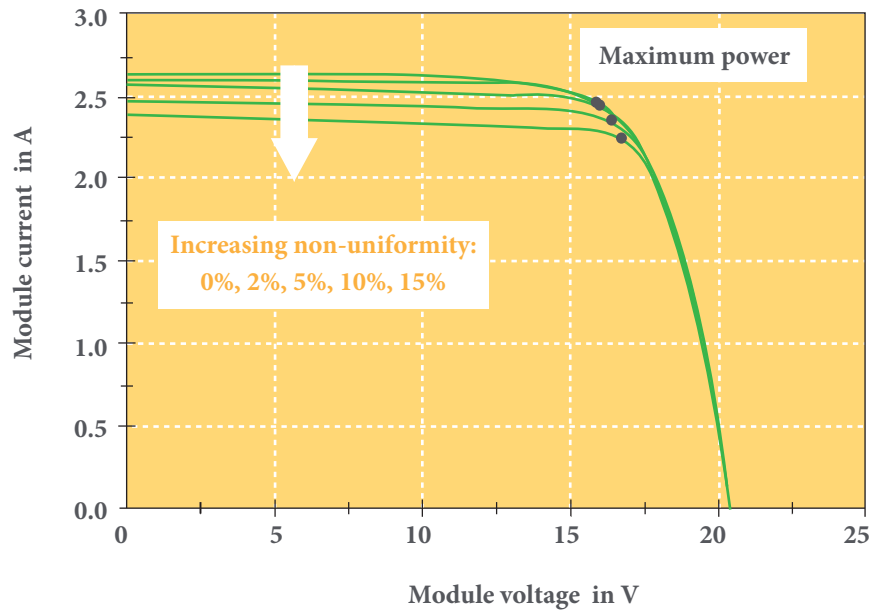

Figure 5: Effect of non-uniformity on I-V measurements: ISC decreases and FF increases with rising non-uniformity; maximum power is not affected if non-uniformity <5%.

Temporal instability of irradiance

During the I-V data acquisition sweep irradiance is normally not completely stable but subject to fluctuations. As the photocurrent generation of cells follows these fluctuations, an irradiance correction of each I-V data point to the target irradiance level is required. Measurement errors related to irradiance correction are directly linked to the module parameters. Therefore, exact knowledge of module I-V correction parameters – such as internal series resistance – is important to keep the correction uncertainties low. Against this background, the standard IEC 60904-9 defines a method for classifying solar simulators (Table 2), which includes three quality indicators. Suppliers of solar simulators for PV power measurement must specify the respective class for each indicator (e.g. AAA).

Table 2: Classification of solar simulators for power measurement

Quality indicator	Methode	Classification		
		A	B	C
Non-uniformity of ir radiance	Monitoring of irradiance distribution in the test area. Calculation from measured Min/Max values of irradiance	<2 %	<5%	<10%
Spectral match to AM 1.5 reference spectral Irradiance (IEC 60904-3)	Ratio of irradiance contributions of 6 wavelength ranges (400-500-600-700-800-900-1100): Solar simulator/AM 1.5 reference	0.75 to 1.25	0.6 to 1.4	0.4 to 2.0
Temporal stability of emitted light (LTI = Long Term Instability)	Monitoring of irradiance at a fixed position in the test area. Calculation from Min/Max values during I-V data acquisition time	<0.5%	<2 %	<10%

Nowadays class AAA solar simulators are commercially available and several types have been qualified by independent parties. Module manufacturers normally use data sheets as basis for their buying decision. Verification measurement or assessment of whether the technical specifications are met in operation is not common in industry, since it requires special measurement equipment and expertise (Figure 6). It is advisable to perform confirmatory tests in the plant at least after installation. For solar simulators used in PV module production lines, additional technical details to those given in the data sheet specification are needed to guarantee stable quality of power measurement:

The uniformity of irradiance of a solar simulator is influenced by the test environment, such as dimensions of the test chamber or the internal reflective conditions. Deviations from the standard test environment can lead to variations in the spatial uniformity of irradiance. Therefore, any self-developments by a module manufacturer shall carefully be evaluated.

Solar simulator lamps age and need to be replaced after a certain time of operation. Therefore operational-relevant characteristics such as spectral irradiance may change and should be checked so that appropriate corrections to the power measurement results can be made if needed. Furthermore, the radiation characteristics can differ from lamp-to-lamp and may lead to variations in the irradiance uniformity in the test area.

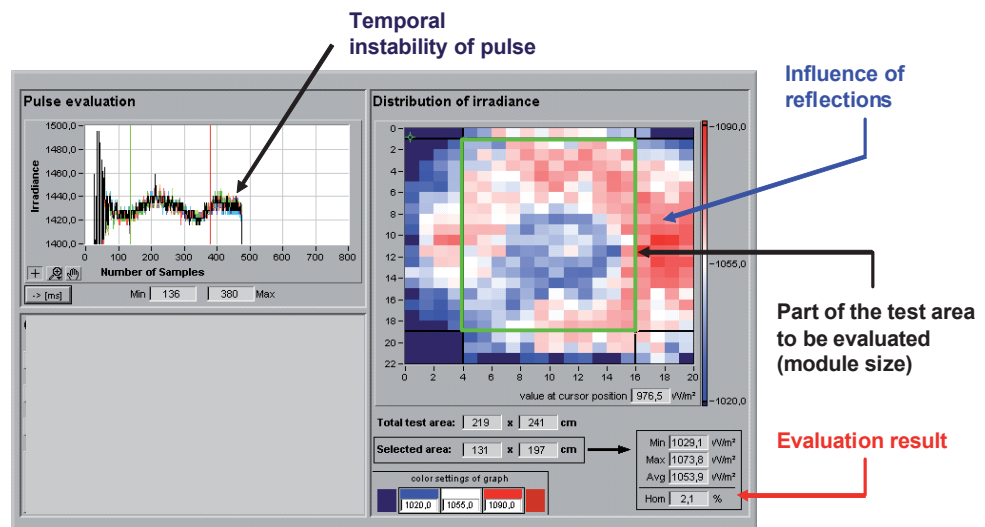
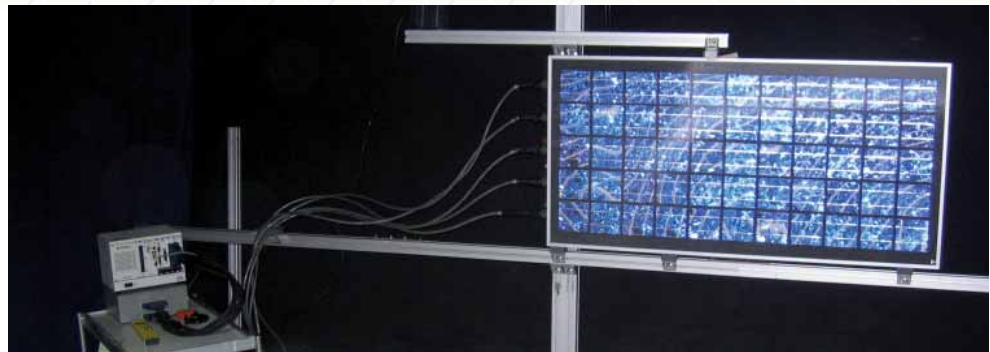

Figure 6: Example of the quality control equipment for checking the performance of solar simulators: above a special module with individually measured cells; below: software output showing results of checks on temporal stability and uniformity (courtesy TÜV Rheinland)

The details given by the systems suppliers for irradiance non-uniformity are not sufficient for manufacturers who produce modules of different sizes. Regarding this point, clear recommendations should be given by the systems suppliers.

Data tables for non-uniformity of irradiance and spectral irradiance should be provided by the simulator supplier to facilitate optimal positioning of modules and spectral mismatch calculation respectively.

3.2 Reference Devices and Spectral Mismatch Correction

3.2.1 Main Requirements

For calibration measurements the irradiance level can be determined with a reference device. IEC standard 60904-2² defines these as follows:

“Reference solar devices are specially calibrated devices which are used to measure natural or simulated irradiance or to set simulator irradiance levels for measuring the performance of other solar devices having similar spectral response, optical characteristics, dimensions and electrical circuitry.”

The general requirements for a reference device in IEC 60904-2 are **stable** photovoltaic characteristics and **linear** variation of the output signal with irradiance. The stability requirement in IEC 60904-2 is fairly weak:

“if the calibration value of a reference device has changed by more than 5% of the initial calibration, it shall not be used as a reference device”.

The requirements for mechanical construction, optical properties and electrical circuit are also defined. The factors are reflected in the recommended reference devices for module measurements as follows:

*“The use of a **full-size reference module** is recommended in measuring other modules in order to achieve correspondence of dimensions, mechanical construction, optical properties and electrical circuitry of the reference module and test specimen, so as to minimize discrepancies due to simulator non-uniformity, internal reflections or temperature distribution.”*

Silicon cells and modules can fulfil the stability and linearity requirements, if carefully selected, and well established calibration procedures for full size modules are available. Si reference modules can in principle be built with different kinds of Si cells provided the match to the particular module under test is achieved.

For other solar cell materials it would be ideal to also have modules of the same size and material to avoid the above-mentioned mechanical, optical and electrical problems. In the ideal case a reference device is available with a spectral response which resembles very closely or equals the spectral response of the test device. In this case the spectral mismatch can be eliminated, irrespective of possible discrepancies between test and standard spectrum. The details of the spectral mismatch correction are explained in “IEC 60904-7 – Computation of spectral mismatch error”.

² The new version of this standard (IEC 60904-2, March 2007) merges the previous versions IEC 60904-2 (Photovoltaic devices. Part 2: Requirements for reference solar cells) and IEC 60904-6 (Photovoltaic devices. Part 6: Requirements for reference solar modules).

For measurements under flashers the spectrum changes during the decay of the flash and thus doesn't correspond to the reference spectrum at least for part of the measurement. In such cases it is especially important that a suitable reference device is used. The following test is available for the quality of the spectral match of the reference device and the device to be measured [1, 2]: if during the decay of light intensity of a (large area) pulsed solar simulator the spectrum has a marked red shift, the short circuit current of both devices (reference and test device) can be measured simultaneously against time. The normalized ratio of short circuit current of device to be measured over short circuit current of reference device is then plotted against irradiance as determined by the reference device. For a good match this ratio should remain constant with irradiance change. (The deviation indicates the mismatch factor at the given irradiance.) This test can be performed easily and quickly, and could be used to determine which out of a selection of reference devices has the best match to the device to be measured.³ It should, however, be established that a sufficient red shift of the spectrum does exist using appropriate measurement equipment.

3.2.2 Spectral Mismatch

The spectral mismatch caused by the differences of the simulator spectrum to the standard spectrum in conjunction with different spectral responses of reference and test cell is potentially significant error source for all devices. It can be corrected by a mismatch factor M :

$$M = \frac{\int SR_{TC}(\lambda) \cdot E_{SIM}(\lambda) d\lambda}{\int SR_{TC}(\lambda) \cdot E_{STC}(\lambda) d\lambda} \cdot \frac{\int SR_{RC}(\lambda) \cdot E_{STC}(\lambda) d\lambda}{\int SR_{RC}(\lambda) \cdot E_{SIM}(\lambda) d\lambda} \quad (1)$$

with	$SR_{TC}(\lambda)$	spectral response of the cell under test
	$SR_{RC}(\lambda)$	spectral response of the reference cell
	$E_{SIM}(\lambda)$	spectral irradiance of the simulator spectrum
	$E_{STC}(\lambda)$	spectral irradiance of the standard spectrum

3.2.3 Practical Considerations

- For c-Si modules straight from production, it is advisable that these are exposed to sunlight (either real or simulated) to an irradiation level of minimum 5 kWh/m² in order to exclude any effects caused by light induced degradation before the first calibration. During the exposure time the module shall be open circuited or operated with resistive load which is sized so that it operates near the maximum power point at STC.

³ This test of course requires the absence of capacitive, resistive and light soaking effects for test and reference device which could resemble or add to the spectral mismatch effect.

- Temperature and irradiance correction of the measured I-V characteristic might become necessary when the reference module is used for adjustment of the solar simulator. This translation shall follow the procedure of the standard IEC 60891 and is normally automatically done by the operating software of the solar simulator. Care should be taken that the correct temperature and irradiance correction parameters for the reference module are used.
- The frequent use of reference modules can cause deterioration of the electrical contacts such as connectors or terminals, which are often not designed for repeated connection and disconnection. In particular, measurement errors can be introduced if the calibrated maximum power is referenced for adjustment of the solar simulator. Therefore, the quality of the contacts shall be regularly checked (i.e. measurement of the module internal series resistance, cross check of working reference with the primary reference) and the reference module replaced, if necessary.
- Range, type and pre-treatment: The reference module should as far as possible be identical to the production modules, especially in cell size, cell technology, the total number and interconnection of the cells. This usually requires a set of reference modules, with one for each of the different production setups. Optimally, two modules of each reference design should be available with an overlapping calibration interval. As mentioned above reference modules should be stabilized before the first calibration i.e. with light soaking of 5 kWh/m^2 under load or V_{oc} -conditions. It is further recommended to check the stability of the measurement results in each case after irradiation and after a subsequent dark storage of 24 h. If a module type does not exhibit stable behaviour, a procedure must be determined for its pre-treatment before calibration and for stabilisation before each use as a reference module.
- Calibration and internal control: A check of the traceability of the electrical parameters of reference modules should be done at yearly intervals. It is recommended to use a larger group of type specific reference modules for cross-comparison with working standards and between different reference modules in a much shorter time intervals. Thus the stability of both the individual modules as reference and the simulator features can be monitored. A further check of the stability should be done through the comparison of calibration and actual measurements of short circuit current after setting the irradiation intensity of the solar simulator based on the calibration of P_{max} .
- Handling and Use: Reference modules should be subject to a documented and organized management. The use of primary and working reference is recommended. The references should be stress free as far as possible, that is, they should only be exposed to low radiation, be kept at a constant temperature level and mechanical stress during storage and handling should be minimized. The solar simulator is primarily adjusted to P_{max} of the reference module. The resulting deviation of the I_{sc} reference module is monitored and used as a quality criterion. For example, one should consider an deviation interval of $\pm 0.5\%$ triggering documentation and information of those responsible. An adjustment of the calibration shall be undertaken only in consultation with appropriately trained personnel. If a larger barrier (for example $\pm 2\%$) is exceeded a comprehensive investigation should be initiated, to preclude malfunctioning as the cause. The measurements themselves are set in advance

and developed in line with the experience gained. Where possible reference module measurements for both I_{sc} and V_{oc} should be made in accordance with I_{sc} . The deviations of the results can also serve as a quality criterion. Reference module measurements before and after the measurement of the production modules can reveal drifting otherwise unnoticed.

3.2.4 Non-Crystalline Silicon Modules

The IEC standards were developed for crystalline silicon devices, and the majority of reference cells and modules employed up to now are also based on crystalline silicon. For indoor calibration of traditional crystalline silicon devices measurement accuracies of about $\pm 2\%$ have been achieved in the leading calibration labs [3]. Other solar cell materials and high efficiency silicon modules are not as “well-behaved”. Problems which can arise are:

- different thermal behaviour under illumination depending on the kind of encapsulation (bare Si-cells; metal case; thin film between two glass plates; glass front and plastic back-sheets, etc.), leading to an uncertainty in the determination of the correct junction temperature and thus in the PV properties of the devices
- capacitive effects: the efficiencies measured with a flasher as a light source may not correspond to those measured under steady state light (e.g. outdoors) due to high carrier lifetimes or properties of the metal-semiconductor contacts.
- “resistive mismatch”: homogeneous solar thin films represent a different resistive network than single Si cells, possibly adding to the problem of the capacitive effects when measured under a flasher
- light soaking effects: the samples change their properties under illumination on a time scale of seconds to minutes/hours
- seasonal variation of efficiency (due to thermal annealing)
- spectral mismatch: a spectral response different from standard (mostly Si) reference devices, leading to a spectral mismatch between reference and test device if the spectrum of the solar simulator differs from the standard spectrum (which is the case for all present simulators, see below)
- multijunction cells require the spectrally appropriate illumination of each junction
- optical mismatch: thin film modules with their homogeneous film coverage have internal light reflections which differ from (reference) modules with single Si cells and intermediate space
- as the electrical performance of thin-film modules can vary considerably (fabrication tolerance), care must be taken regarding the use of a constant spectral mismatch factor for those modules. Also the module parameters for the temperature and irradiance corrections according to IEC 60891 might differ for thin-film modules of different efficiency classes from the same manufacturer and should be carefully evaluated. A guide is given by test standard IEC 60904-5, which describes a method to derive the equivalent cell temperature (ECT) from V_{oc} and irradiance measurement.

These issues are addressed with respect to specific technologies in section 5.

4. Measurement Procedures

4.1 Module Measurements on Simulators

Nowadays the great majority of PV module manufacturers use pulsed solar simulators with xenon lamps for power measurement but the I-V measurement hardware and measurement techniques still vary widely. This section therefore aims to provide a set of practical recommendations for module manufacturers aiming to harmonise measurement methods and to improve the quality of their power measurements. These are based on findings of the PERFORMANCE Sub-Project 1, the results from the German research project “Characterisation of PV modules in PV module production” co-ordinated by Fraunhofer-ISE and experiences from TÜV Rheinland’s factory surveillance programme as a part of module production certification.

4.1.1 General

- General requirements for solar simulators are laid down in IEC 60904-9.
- General requirements for I-V measurement are laid down in IEC 60904-1.
- Recalibration intervals of the I-V measurement equipment and the temperature data acquisition shall not exceed 12 months. As normally the I-V load is integral part of the solar simulator, special calibration services provided by the systems supplier may be required.
- Repeated use of reference modules will lead to deterioration of the electrical contact quality i.e. an increase of contact resistance. Therefore, the cable adapters for the 4-wire connection to the I-V load shall be checked and replaced regularly.
- Responsibilities for power measurement shall be clearly defined: Who is allowed to operate the simulator? Who is allowed to define module types? Who is responsible for maintaining the module data base? etc.
- To compensate deficits in understanding of the working principle of solar simulators, training and qualification measures shall be defined for personnel, in particular the quality manager.
- Special care must be taken if systems with non-filtered xenon lamps are used. Spectral mismatch errors can occur for the production tolerances of electrical performance. Procedures for spectral mismatch calculation in accordance with IEC 60904-7 shall be in place.

4.1.2 Requirements for Reference Modules

- Basic requirements are defined in IEC 60904-2.
- Reference modules shall be electrically stable. For example, amorphous devices will change performance with irradiation. Also c-Si modules may be subject to light induced degradation as solarisation of the glass cover can reduce transmittance or boron doped mono-Si cells may require initial stabilisation. Recommendations of the suppliers shall be followed to ensure stabilisation.
- Reference modules shall cover the range of produced modules (module size, cell technology, interconnection circuit of cells etc.). This normally requires a set of reference modules. There must be a clear assignment to module types.
- Instead of originally calibrated reference modules provided by a test laboratory (“master” reference) “working” references shall be introduced for everyday use. “Working” references shall be of the same type as the “master” reference. These shall be regularly cross checked with “master” references.
- Besides calibration data, measurement reports of reference modules shall include module I-V correction parameters as laid down in IEC 60891 (i.e. temperature coefficients, series resistance). These shall be made available in the internal module data base.
- The module data base shall also contain information on I-V data acquisition parameters to avoid transient effects caused by high sweep rate (segmental measurement mode, I-V data acquisition time, I-V delay time after receiving trigger signal)
- The frequency for the use of a “working” reference shall be sufficient to guarantee that the reproducibility between the I-V measurements is within $\pm 0.5\%$. The best-practice definition shall reflect the experience of the manufacturer. Typical definitions are: once per day, at the beginning of every new working shift and after a change of module type.
- Reference modules shall be stored in a safe and controlled environment to guarantee electrical stabilisation. Furthermore, any mechanical stress shall be avoided.

4.1.3 Choice of Main Parameter for Calibration

There are two ways to verify a reference module’s calibration data:

- a) reference module delivers calibrated I_{SC} , and
- b) reference module delivers calibrated P_{MAX} .

The advantages and disadvantages of the two ways are summarised below. Normally, it will not be possible to exactly reproduce both I_{SC} and P_{MAX} . Depending on which is chosen, the second parameter is then floating. However, the measured I_{SC} , P_{MAX} and V_{OC} should in any case be in agreement to within $\pm 1\%$ of calibration data. Any larger discrepancy could indicate the following problems:

- | | |
|--------------------------|--|
| Discrepancy on V_{OC} | ▶ check module temperature measurement |
| Discrepancy on I_{SC} | ▶ check contacting technique, module temperature measurement |
| Discrepancy on P_{MAX} | ▶ check uniformity of irradiance, sweep rate |

I_{SC} of the reference module

- Advantage:** Almost independent from module temperature and connection technique
- Disadvantage:** Non-uniform illumination of a module will mainly affect I_{SC} of a module. Increase of non-uniformity will cause lower I_{SC} . Thus a higher irradiance setting is required to deliver calibrated I_{SC} . This means overestimation of module power.

P_{MAX} of the reference module

- Advantage:** Better compensation of non-uniformity effects
- Disadvantage:** Requires a careful module temperature measurement and connection technique. Bad contact will cause higher irradiance level to deliver calibrated P_{MAX} . This means overestimation of module power.

4.1.4 Calibration Procedure

Step 1: Instrumentation: The “master” or “working” reference is placed in the pre-defined position in the test area with optimal uniformity of irradiance. The module is connected to the I-V load (4-wire connection) and temperature sensors are attached.

Step 2: Operation software: As the measurement conditions may differ from STC, the module type’s specific characteristics must be transferred into the operating software of the solar simulator (i.e. temperature coefficients, internal series resistance). Based on the measured I-V curve the software will calculate and display the temperature and irradiance curve corrected to STC.

Step 3: Control measurement with reference module: If temperature conditions are fulfilled the first I-V measurement with the reference module is performed. If measurement results lie within pre-defined tolerances compared to the calibrated values, e.g. $\pm 1\%$ of the “working” reference, production line measurements can be continued.

Step 4: Re-adjustment of solar simulator: If the criterion under Step 3 is not fulfilled the scaling factor of solar simulator irradiance sensor is adjusted accordingly. The new setting is verified by repetition of Step 3.

4.1.5 Module Temperature Measurement

- Measurement error for P_{MAX} is approx. 0.5% per K
- If ambient temperature is referenced, modules from production shall be given sufficient time to adjust to ambient.
- Possible temperature distribution across the module area shall be checked. The position of the temperature sensor used as the reference for temperature correction shall represent the average module temperature.
- A minimum of 2 temperature sensors shall be used in order to make a plausibility check of the reading possible.

4.1.6 Quality Assurance

- Effective irradiance shall lie in the range of 1000 W/m^2 in order to keep the irradiance correction low for measured I-V curve.
- Uniformity of irradiance shall be checked regularly. In particular, after changing lamps or any kind of maintenance work that might change the reflective conditions. Marks shall define the test locations for different module sizes.
- A data table of spectral irradiance shall be available to allow spectral mismatch calculation in accordance with IEC 60904-7.

4.2 Outdoor Measurements

Although outdoor measurement is not normally considered in relation to PV production lines, in some circumstances such measurements may be preferred for selected modules. The main advantages of using natural sunlight are:

- Very uniform illumination of the PV module
- Cheap, does not require expensive light sources
- Inexpensive measurement equipment
- Stable during good weather conditions
- Easy characterisation of “slow response” devices
- Air Mass can be chosen to be close to 1.5

There are disadvantages however:

- Subject to the weather
- Inherently variable illumination throughout the day
- Changing air mass with time
- Difficult to control measurement environment, ie module heats up with exposure

Outdoor measurements are typically realized under test conditions close to STC using a set-up with a solar tracker. With clear-sky conditions, the air mass of the natural sunlight around noon is close to AM1.5G. The spectral distribution of the incident sunlight can in any case be measured, for instance using a horizontally-mounted spectroradiometer. The measured spectrum is used as an approximation to the in-plane spectral irradiance distribution. The weighting between the diffuse and the direct component is therefore different, which will change the mismatch factor. However, the mismatch correction for outdoor measurements is generally small as the solar spectrum is close to the reference spectral irradiance. In fact the mismatch correction is normally smaller than the associated uncertainty. This may justify omitting the explicit spectral mismatch correction and considering the same uncertainty contribution as if it were done.

One complicating factor with outdoor measurements is the need to carefully control the temperature of the device under test and to avoid (or minimise) the module's exposure to light before the measurements, in order to avoid conditioning the device. The accepted temperature range is typically broader than indoors e.g. $25 \pm 2^\circ\text{C}$. The temperature of the reference should also be controlled. If a reference cell is being used it can be mounted on a Peltier device, which combines electrically controlled heating or cooling.

5. Technology-Specific Issues

5.1 High Efficiency Silicon Modules

High efficiency c-Si modules – in the form of either by back contact or HIT cells – are usually highly capacitive and power measurements can be influenced by sweep-time effects when the IV scan acquisition times are too fast (generally already below 200 ms). Mau [4] gives an overview of capacitive module types together with their response times.

The fast I-V sweeps of these kind of modules can lead to under- or overestimations of over 20% for the measured power P_{MAX} , depending on sweep-time and sweep-direction (I_{sc} to V_{oc} or *vice versa*) and puts severe constraints on the pulse duration of the flashers used to test these devices in a lab. Figure 7 shows the values of the power P_{MAX} of a high-efficiency c-Si device measured as a function of the sweep-speed and sweep direction [5]

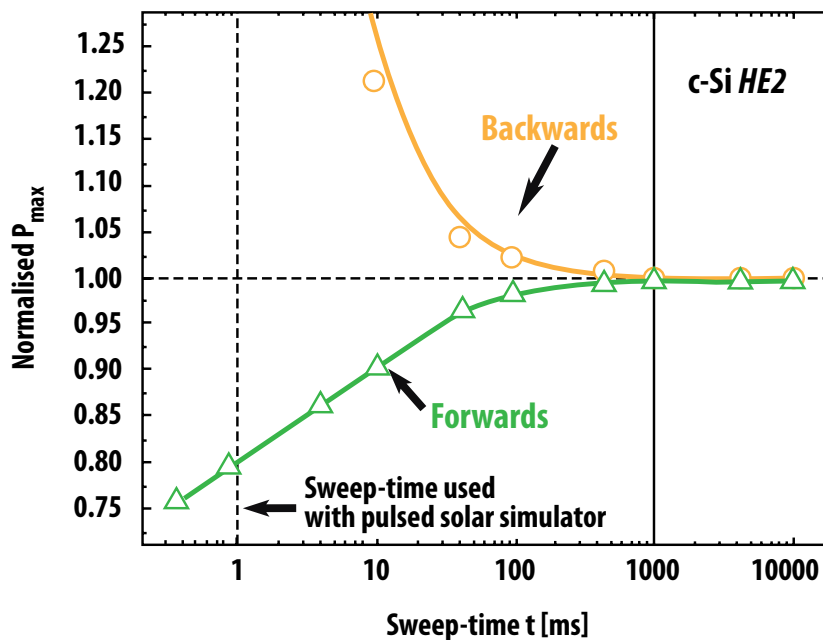

Figure 7: Power of a high-efficiency c-Si module as a function of the sweep-speed [5] (P_{max} is normalised to the 1s value; forward sweep is I_{sc} to V_{oc}).

The capacitance of a solar cell has three different contributions: 1) the *junction capacitance*, which represents the charge storage in the depletion layer of the pn junction, (dominating in reverse and low forward bias conditions); 2) the *diffusion capacitance*, which corresponds to the minority carrier storage in the quasi-neutral regions of the junction (significant in forward bias). This capacitance is significant for solar cells with high minority carrier lifetime; and 3) the *transient carrier capacitance*, which can be attributed to the existence of defect and interface states [6]. The last two contributions depend exponentially on the applied voltage. This allows combining the two into the *free carrier capacitance*. The diffusion capacitance is the main responsible of the measurement artifacts described in this section, as shown in Figure 8. The *diffusion capacitance* has the following dependence on the applied voltage V :

$$C_{\text{diff}} = C_0 \exp(b kT/q V), \quad (2)$$

Where C_0 and b are constants, k the Boltzmann constant, q the elementary particle charge, and T the temperature. Typical values of for the total capacitance of a high efficiency solar cell vary from 30 to 100 $\mu\text{mF}/\text{cm}^2$ and are 100 times higher than for conventional solar cells.

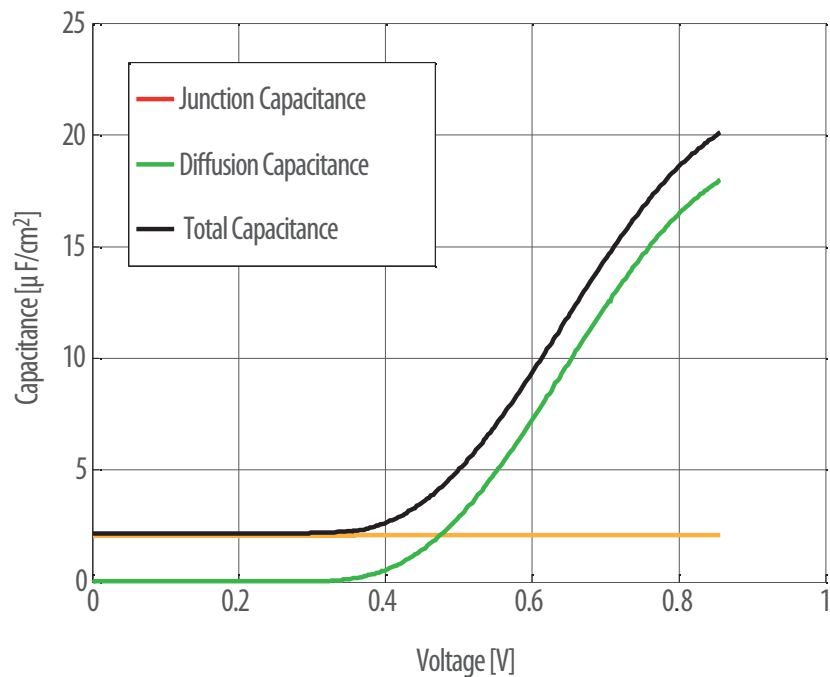

Figure 8: Junction, diffusion and total capacitance of a high-efficiency c-Si solar cell (from [6]).

For a correct simulation of the electrical cell performance through an equivalent circuit model the free carrier capacitor must be placed in parallel to the junction capacitance, the diode and the shunt resistance (Figure 9). During very fast IV scans, the charging or discharging of the capacitor may influence the IV measurement itself. The total current is given by:

$$I = I_d + I_{sh} + I_c - I_{ph} \quad (3)$$

where I_d , I_{sh} , and I_c , represent the currents through the diode, the shunt resistance, the capacitors respectively, and I_{ph} the photo-generated current. I_c is given by:

$$I_c = \frac{dQ_c}{dt} = \frac{dCV_c}{dt} = C \frac{dV_c}{dt} + V_c \frac{dC}{dt} \quad (4)$$

where Q_c is the capacitor charge, C the total capacitance of the cell and V_c is as shown in Figure 9.

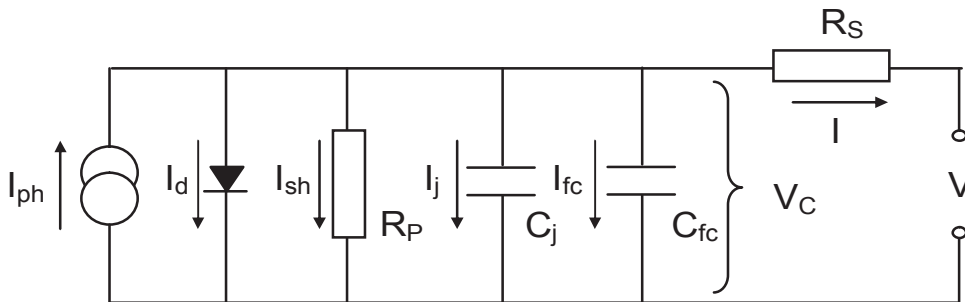

Figure 9: Dynamic single diode equivalent circuit model of a solar cell.

Several other factors can also influence the shape of the IV-curve.

1. The cell capacitance C itself;
2. Numbers of cells connected in series or parallel (the higher the number of cells in series or the lower the strings in parallel, the lower is the total capacitance of the module);
3. The cell area (the cell capacitance is directly proportional to the cell area);
4. The series resistance;
5. IV sweep speed (dV/dt), which is especially high for short pulse simulators;
6. Sweep direction (I_{sc} to V_{oc} or *vice versa*);
7. Number of IV points or scan time (too many points increases the risk of transient errors);
8. The temporal profile of the irradiance which gives the current gradient dI/dt .

Even if the voltage is held constant during the whole measurement ($dV/dt=0$), the current needs to stabilize. For very high capacitive modules or very short light pulses (~ 2 ms) this effect cannot be neglected.

As an indication of the accuracy that can be expected using best practice methods, a recent inter-comparison in made as part of the Performance Integrated Project showed repeatability of P_{\max} values in a range of -1% to $+1.3\%$. This is only slightly larger than the $\pm 1\%$ range expected for non-capacitive c-Si modules.

5.1.1 Measurement Equipment

The high capacitance of high efficiency modules makes it difficult to characterize them in a single flash using very fast electronics, so that several precautions should be taken into account. As noted in IEC 60904-1, the presence of sweep-time effects can be checked by performing a sweep in both directions (I_{sc} to V_{oc} and *vice versa*). The divergence of the two I-V curves gives an indication whether capacitive effects exist for the given measurement conditions. Moreover IEC 60904-1 requires that *“the time interval between the data points shall be sufficiently long to ensure that the response time of the test specimen and the rate of data collection will not introduce errors.”*

The typical duration of light pulses for indoor flasher usually varies between 1 to 20 ms with different temporal profiles (rectangular shape or decaying pulse). These intervals are too short for a proper characterization of high-efficiency c-Si modules within a single flash without introducing measurements artefacts related to capacitive effects. Other pulsed solar simulators available on the market have longer pulse durations (80-100 ms). These flashers would be more suitable for these devices – though some devices require even longer pulse durations (see Figure 7) – but are usually extremely expensive.

Figure 10 shows the results of IV curve measurements on a high-efficiency c-Si solar cell, realised with different approaches: 1) slow speed “*steady state*” IV curve (green line), 2) high speed IV direct (from I_{sc} to V_{oc}) sweep realized with a 2ms flasher (red points), and 3) high speed IV reverse (from V_{oc} to I_{sc}) sweep realized with a 2ms flasher (blue points) [6]. The steady state curve was obtained with one of the approaches described in Section 5.1.3.

Usually PV modules are measured in forward direction (from I_{sc} to V_{oc}). In this case we observe an underestimation of power and V_{oc} , whereas for reverse sweeps (from V_{oc} to I_{sc}) a strong overestimation of P_{\max} is observed. The asymmetry is due to the presence of the term $R_s \cdot dI/dt$. For this cell IV sweeps in the range of 1-2 ms lead to under- and overestimations of up to 10% and 30%, respectively, depending on the sweep-direction.

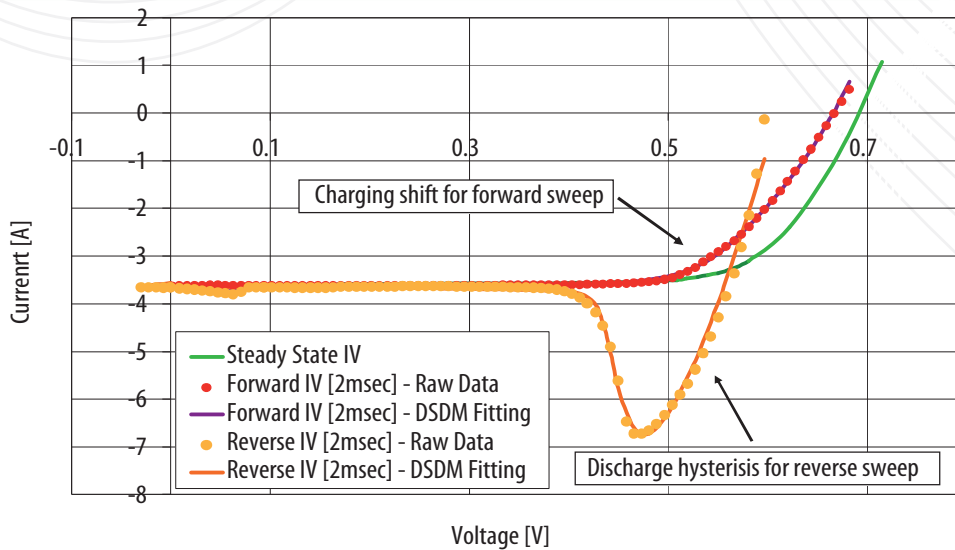

Figure 10: IV curve measurements on a high-efficiency c-Si solar cell realised with different approaches: 1) slow speed “*steady state*” IV curve (green line), 2) high speed IV direct (from I_{sc} to V_{oc}) sweep realised with a 2ms flasher (red points), and 3) high speed IV reverse (from V_{oc} to I_{sc}) sweep realised with a 2ms flasher (blue points) [6].

5.1.2 Measurement Procedures

Some of the module technologies present today on the market require pulse durations up to 250 ms to allow a correct I-V measurement, but there is no pulsed solar simulator on the market able to reach these irradiance durations. It is also expected that the trend towards more efficient modules and the number of such module technologies on the market will continually increase. With the sweep time being defined by the flash duration of the simulator, the only way to avoid these measurement errors is to apply special procedures or to develop solar simulators with very long pulses (> 100 ms). This second approach is not considered here (it likely to be very expensive solution and may introduce additional problems such as module heating and the subsequent need for temperature correction).

The following approaches are considered below:

- Outdoor characterization;
- Steady state solar simulator;
- Multi-flash point by point measurement;
- Multi-flash measurement by sections;
- Multi-flash modulated voltage measurement.

Outdoor characterization

Outdoor performance measurements allow the realization of low-speed measurements and can easily provide a solution to the problem of sweep-time effects for high efficiency c-Si modules. Advantages and disadvantages of this approach are listed in Section 4.2. However it cannot be applied as an integral part of module production quality control.

Steady state solar simulator measurement

Steady state solar simulators allow the realization of low-speed measurements and could provide a solution to the problem of sweep-time effects for high efficiency c-Si modules also in a production environment, where high throughputs are required. However, the equipment is generally very expensive and other problems arise. For example, the module under test requires carefully temperature monitoring and the subsequent application of temperature corrections to the measurement, which may also introduce an additional source of measurement error. The heating of the measurement environment (lab or production line) should also be considered. Moreover, such equipment typically uses a series of lamps which may have different aging rates, so careful and frequent monitoring of the irradiance uniformity on the measurement plane is necessary.

Point-by-point multi-flash measurement

This method allows the use of conventional flashers for the performance measurement of these devices. The voltage is held constant during the light pulse and only one current –voltage (IV) data-pair is measured during each pulse. A full curve of current-voltage points is obtained by making multiple flashes – each with different applied voltage – and then extracting the relevant data. The method does not require a temperature correction and has been applied with good results to all existing c-Si technologies, as shown in Figure 11, though for very high capacitive modules the method should be carefully checked a priori, as the current could not be able to stabilise at voltages $> V_{max}$ when very short light pulses (~ 2 ms) are used. This approach is however very time consuming (flashes and charging time between flashes) and requires 15 – 20 flashes in order to obtain a reliable IV curve. Interpolation of data points is then required to extract the PV parameters from the curve. Moreover, the accelerated aging of lamps should be considered.

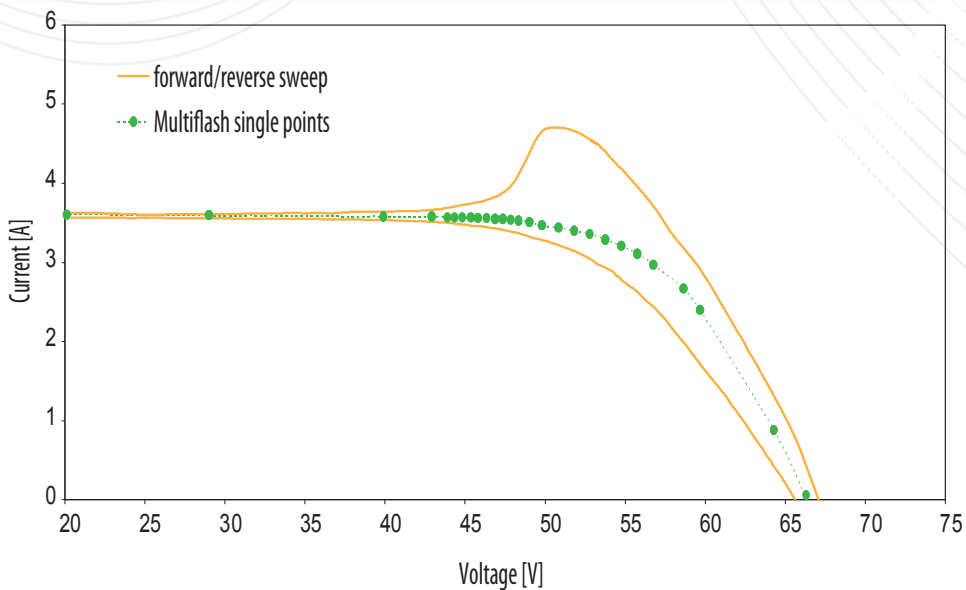

Figure 11: IV curve measurements of a typical high-efficiency c-Si solar module, realized by means of different approaches: 1) multi-flash IV curve (red points), 2) high speed IV direct (from I_{sc} to V_{oc}) sweep realized with a 2ms flasher, and 3) high speed IV reverse (from V_{oc} to I_{sc}) sweep realized with a 2ms flasher.

Sectional multi-flash IV measurement

This method allows the use of conventional flashers for the performance measurement of these devices. With this approach a varying voltage is applied during the light pulse, but the module is swept from I_{sc} to V_{oc} (or *vice versa*) not in one single measurement but during subsequent IV scans (segments). A full IV curve is then obtained by repeating multiple flashes and attaching the different sub-sections together.

This method does not require a temperature correction and can be applied with good results to all existing c-Si technologies, as shown in Figure 12, though for very high capacitive modules the method should be carefully checked a priori. The current is in fact not able to stabilise at voltages $> V_{max}$ when very short light pulses (~ 2 ms) are used. Compared to point by point multi-flash IV measurements, less flashes are required when measuring low/medium capacitive modules. This approach is however time-consuming (flashes and charging time between flashes) and the number of required sections has to be verified in advance to get good matching of sections and to avoid transient errors within single sub-sections.

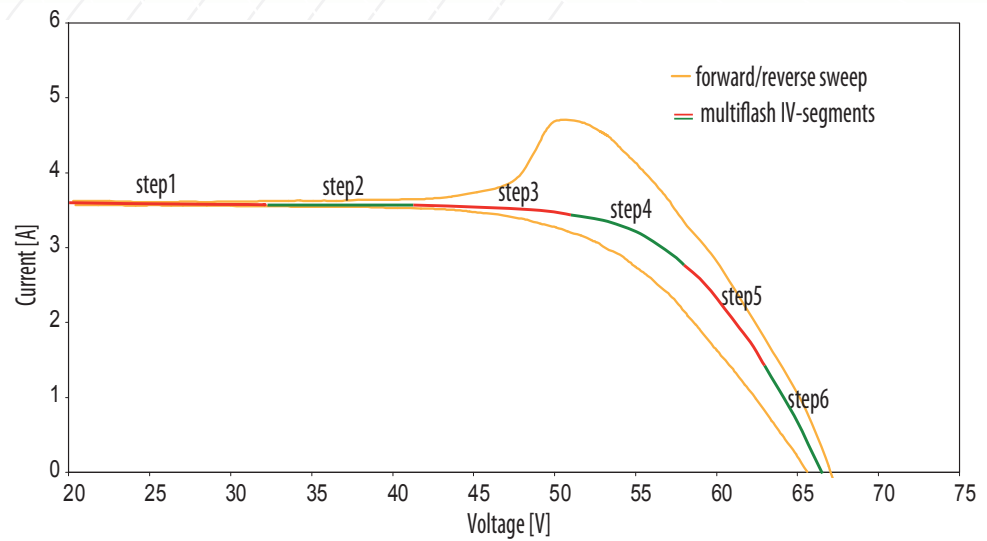

Figure 12: IV measurements of a typical high-efficiency c-Si module using: 1) multi-flash segments and 2) high speed forward (I_{sc} to V_{oc}) and reverse (V_{oc} to I_{sc}) sweeps with a 2 ms flasher

Voltage modulation multi-flash measurement

The point-by-point multi-flash method with a constant voltage applied during the whole sweep has, however, shown to be limited in the case of very short pulses (≤ 2 ms) and voltages above V_{max} when very high capacitive modules are measured. This error has been correlated to changes in the charge stored within the cell. Today only one commercial technique overcomes this problem [7]. Rather than applying a constant voltage to the module during the pulse, the voltage is modulated with a small signal proportional to the current flowing at the terminals ($V = V_{const} - k_2 \cdot I$). The small signal term $k_2 \cdot I$ is designed to maintain constant the charge within the solar module. In this way it counteracts changes in the electron- and hole-density profiles in the solar cells, as well as voltage drops due to wiring, solar cell metallization and internal series resistances. The result is a faster response time of the module to changing light conditions (Figure 13). The technique needs a preliminary measurement to determine the correct voltage modulation, which may vary from module to module for a given type depending on the manufacturer, production batch or class.

In combination with standard solar simulators with relative long re-charging times in-between flashes, the disadvantages are similar to the ones for all before described multi-flash approaches (e.g. time-consuming technique and accelerated aging of the lamps). The operation with low cost simulators with very short pulses and high repetition rates allows instead to perform a full IV-measurement in a more restricted time, reducing so some of the typical disadvantages of multi-flash methods.

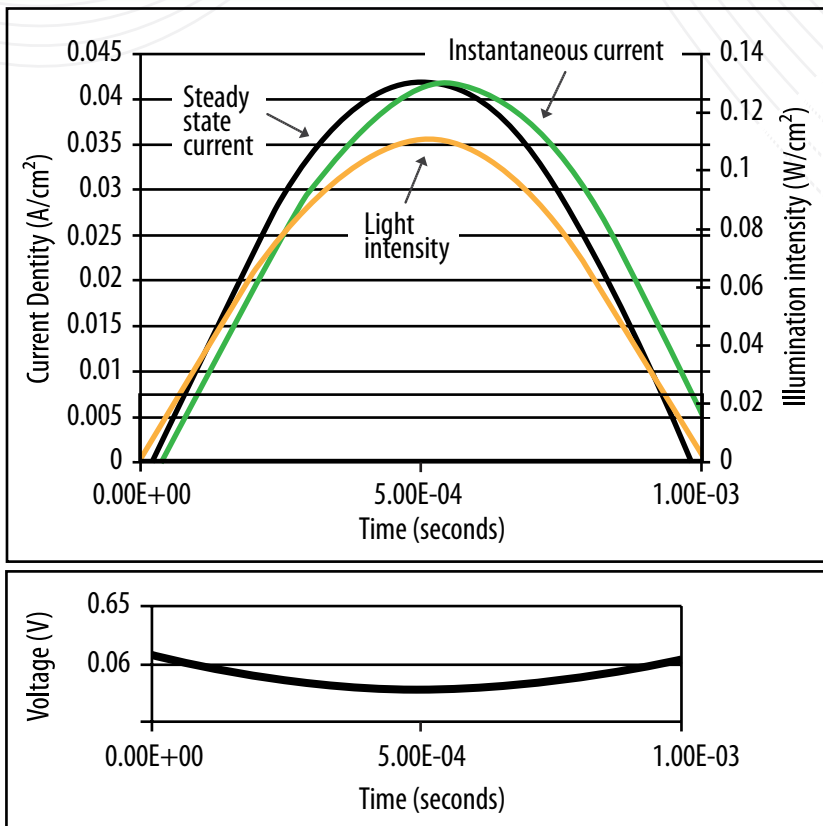

Figure 13: Multi-flash approach with the Sintron voltage modulation. The modulated signal compensates the current delay obtained with constant voltage signals.

5.1.3 Back-Contact Devices

Back contacting is a promising concept to achieve higher efficiencies: the reduction or absence of the metallisation on the front side of the solar cell increases the potential for higher currents. It also opens possibilities for more efficient manufacturing. Back contact modules do not *per se* present specific problems for power measurement, since the module design implicitly includes a solution to back contact issues. It may however be necessary to consider capacitive effects i.e. it should be demonstrated that the sweep time used is sufficient to avoid transient effects. This can typically be checked by performing a sweep in both directions (I_{sc} to V_{oc} and *visa versa*). Divergence of the two I-V curves is an indication that capacitive effects exist for the given measurement conditions. This may be resolved by adopting longer sweep times.

The situation with regard to characterising bare cells is more complex, since problems such as contacting and temperature uniformity must be addressed.

- a) BCCs have regions without metallisation between the fingers, making them locally bifacial. Mounting chucks are used to contact the solar cell electrically and thermally. A metallic surface provides a good thermal contact, but for the electrical isolation a coating like an oxide, a foil or paint is necessary. The

surface of the chuck has a characteristic reflectivity and the resulting errors need to be compensated for.

- b) Cell mounting on chuck: the cell will drop off the chuck with increasing pressure of the contact probes from the back side and holders need to be used to ensure proper contact during the measurement.
- c) Transmitting holders/cover glass: the wavelength dependence of the transmission of glass has to be taken into account for uncertainty estimation. For a complete glass covered solution inter-reflection (cell-glass, chuck-glass) additional effects have to be considered.
- d) Temperature Uniformity: The electrical isolation between the two types of rear contacts in a BCC is likely to affect the thermal contact. In addition, the wider areas covered by electrical contacts are not thermally contacted. The design of a contact chuck has therefore to find a compromise between electrical and thermal contact.

PERFORMANCE IP has produced a comprehensive guide to back contact cell measurements [8] which should be consulted for further details.

5.2 Thin Film Modules

Up to now there are no international standards which specifically address calibration or power measurement of thin film technologies⁴. The following sections aim to provide guidance on several of the issues that arise in obtaining accurate and representative power measurements for these technologies.

5.2.1 Solar Simulators

It is important to minimise the mismatch between the simulator spectrum and that of the module under test, unless this issue is covered by the use of an appropriate reference device. This situation is particularly complex if the effect of temporal variation of the pulse needs to be considered. Section 5.2.4 provides further details regarding selection of appropriate reference devices.

⁴ The IEC 61646 standard for thin film module qualification includes comparative power measurements. However the pass criterion is that the module be within 10% of the minimum manufacturer's labelled power (also subtracting the lab's measurement uncertainty). The resulting margin is large and this standard is not recommended as a guide for measurements intended for power labelling or for calibrating or verifying the performance of purchased modules.

5.2.2 Capacitive Effects

Several thin film module technologies show capacitive i.e. sweep-time effects. As noted in IEC 60904-1, the presence of sweep-time can be checked by performing a sweep in both directions (I_{sc} to V_{oc} and *vice versa*). The divergence of the two I-V curves gives an indication whether capacitive effects exist for the given measurement conditions. Table 3 shows the general categories and associated PV technologies. Concerning the measurement options for extended sweep times, the reader is referred to section 5.1.1, which addresses this issue in relation to high-efficiency silicon modules and considers the use of long pulse and multi-flash techniques as well as outdoor (natural sunlight) characterization.

Table 3: Capacitive effects and recommended pulse/sweep times

Capacitive / Sweep-speed Effect	Recommended minimum pulse/sweep duration	PV materials affected
no/low	2 ms	c-Si, CIS, CdTe
medium	> 10ms	a-Si based technologies
high	>100 ms	high efficiency c-Si

5.2.3 Pre-Conditioning

The performance of most thin film technologies is significantly affected by light-soaking and thermal history [12,13,14]. Several phenomena can be observed depending on the given technology. These include:

- Long term degradation under light soaking i.e. the well-know Stäbler-Wronsky effect [15], which stabilises after about 1000 hours
- *in situ* variations due to reversible degradation or annealing, often termed seasonal variations
- Dark ageing: degradation during extended storage in low light or dark conditions, which can be recovered either partially or completely by light soaking
- Dark annealing: improvement of performance following occurring during periods in dark conditions; the timescale for this effect can range from very short (minutes) to long (hundreds of hours).

As a consequence an appropriate pre-conditioning treatment needs to be applied to ensure that the performance measurements are representative of those expected in normal operation.

There are no specific power calibration standards for thin films, but the IEC 61646 standard for thin film module qualification provides a procedure for stabilizing the electrical characteristics to provide consistent measurement conditions to check for loss of performance during the required thermal and damp heat cycling, which foresees a series of light soaking periods at 600-1000 W/m² and 40-60 °C module temperature. It is important that the modules are under load during light soaking, using an resistance selected to produce current-voltage conditions close to the maximum power point. Stabilisation is deemed to be reached when measurements from three consecutive periods of at least 43 kWh/m² meet the criterion $(P_{\max} - P_{\min}) / P_{\text{average}} < 2\%$. These P_{\max} measurements shall be performed at any convenient module temperature, reproduced to within ± 2 °C. This addresses the degradation or recovery which can occur during exposure to light when a module is first used or after an extended period of storage in the dark.

It is stressed that IEC 61646 is not a calibration standard. For calibration measurements it is recommended that the testing organisation demonstrate that the light soaking procedure has indeed resulted in stable characteristics e.g. no decreasing trend and/or three successive measurements within the repeatability margins of the measurement system (typically less than 2%).

Further issues to consider in determining the preconditioning procedure include:

- a) possible influence of the light/temperature/time history in the period between the above light soaking and the I-V measurement,
- b) production line situations in which extended/repeated periods of light soaking prior to measurement are not an option, and
- c) proper storage of “stabilised” modules e.g. those to be used as “references” for checking production flasher systems.

These are addressed for generic TF technologies in the following sub-sections.

Amorphous Silicon

PV devices made from a-Si thin film technology (both mono- and multi-junction) are well known to exhibit two types of variations in their electrical characteristics.

- 1) Initial degradation after production caused by light soaking: typically after a few hundred hours of illumination a-Si devices reach a stabilized power level, typically 15-20% less than the initial value. For power measurements this effect can be addressed by using a light soaking procedure such as that specified in IEC 61646.
- 2) Although a-Si modules exhibit well-known seasonal performance variations during outdoor exposure (after stabilization)⁵, for performance measurements of stabilised modules these are not considered critical. These can be avoided by ensuring that the devices under test are stored at a controlled temperature below that used for stabilisation, and only exposed to light for a very short time between different measurements.

⁵ For a-Si a low module temperature (winter) leads to degradation while higher module temperatures (summer) produce recovery by annealing. These phenomena can produce P_{\max} variations of $\pm 10\%$ with respect to the yearly average.

- 3) Dark annealing: if the temperature during dark storage of a apparently stabilised modules is comparable to that which was used for the original light soaking e.g. if this was done outdoors in cool conditions, dark annealing may occur. Under such circumstances the module would require further light soaking after removal from storage to ensure stability. It is clearly desirable to avoid this situation by ensuring the module stabilisation temperature during the initial ageing is adequate and that the temperature during storage and/or transport does not become too high.

CI(G)S

Thin film Cu(In,Ga)Se_2 devices demonstrate pronounced metastable variations [22]. If the devices are stored in the dark, fill factor and V_{oc} decrease considerably (especially at elevated temperatures), I_{sc} is affected only to a minor extent (reflecting changes of the spectral quantum efficiency). This “dark ageing” phenomenon also occurs under other circumstances, such as during the module lamination process, during damp heat tests or between pre-treatment and measurement. It is reversible by light-soaking, although the recovery is not always complete. In general, the improvement is greater for poorer performing devices, but even high efficiency modules can show significant gains. Light soaking in general can strongly influence the performance, even within very short time intervals (from seconds to hours).

It is difficult to predict how a given CI(G)S material will behave and each device is somehow unique. The material’s actual composition or stoichiometry, the deposition temperature and thickness of the CdS buffer layer, the presence of gallium or sulphur in the quaternary (Cu(In,Ga)Se_2) or pentenary (Cu(In,Ga)(Se,S)_2) absorber systems, and the different deposition processes (coevaporation, sputtering and selenization/sulfurization, electrodeposition, etc.) can all influence the meta-stable state. Some devices [12,18] are highly sensitive to light soaking effects and even the exposure to light for fractions of second can alter the response, whereas others are less so.

The considerations for power measurements of CI(G)S modules are therefore as follows:

- a) For one-off calibration measurements of ex-production modules, a light soaking procedure such as that foreseen in IEC 61646 can be applied⁶, although care must be taken to minimise the time between the light soaking and the measurement (typically of the order of minutes); indeed a constant simulator or outdoor measurement set up may be preferable

⁶ For CI(G)S modules a similar stabilisation effect can also be reached using a current soak, by operating in forward bias at currents between I_{mp} and I_{sc} . However this method requires an adaptation of the current to the individual module to ensure uniformity of treatment, a criterion which is much easier to reach with light soaking, especially for different module designs. On the other hand, a current soak can potentially be applied during dark processes e.g. during the lamination. Current soaking is not considered in the IEC 61646 standard.

- b) In the production process a pro-longed light soak is not a realistic option. The following is an example of one producer's approach, based on measurements which showed that large variety Cu(In,Ga)Se₂ modules with initial efficiencies between 10% and 12% stabilised after approximately 20 minutes. Consequently the producer uses a 20 minute light soak at an irradiance of 100 W/m² under an array of fluorescent tubes with true-lite spectrum before the flasher measurement to determine the module power. For repeatable results it is important that the flash simulator measurements are performed immediately after the light soaking procedure. A temperature correction to 25°C is required, which in turn needs an accurate knowledge of the temperature coefficients. It has been verified that the flasher measurements themselves do not cause significant light soaking effects [13].

Cadmium Telluride

CdTe modules fresh from production show annealing on subsequent exposure to light. Before calibrating the modules this phase should be overcome, for instance by applying a light soaking procedure. Dark ageing may occur when modules are stored for prolonged periods, so that also in such cases a light soaking procedure is also needed. CdTe devices are generally less sensitive than CIS to short-term light soaking effects. Nevertheless, the deposition process (close space sublimation, sputtering, etc.) of the absorber and of the buffer layer can influence the meta-stability of CdTe devices as well, so that different devices may behave in a different ways. The recommendations of a major manufacturer [19,20] are as follows:

- for shorter storage times (<5 days) to measure modules after manufacturing, 3 kWh/m² of light soaking is required under open circuit conditions.
- to rate modules following lengthy dark storage, 200 kWh/m² of light soaking is required under MPP conditions; the characterisation should be carried out within 5 days of completion of this procedure.

5.2.4 Reference Devices

The meta-stability of many thin-film technologies (see previous section) militates against their use as reference devices. As a result, filtered or non-filtered c-Si devices are normally favoured, bearing in mind the following:

- If a reference module is used for adjustment of the irradiance level of a solar simulator, this adjustment is only related to the part of the test area which is spanned by the active area of the reference module. Accordingly, ideally the size of the c-Si reference device should be similar to the size of the thin-film test device. In particular, this applies for solar simulators in module production where non-uniformity of irradiance normally lies above 2%.
- Since c-Si reference devices are not spectrally matched to thin-film technologies, there can be considerable spectral mismatch. For non-filtered xenon lamps for example, this be in the range of 30%. If spectral mismatch cannot be calculated (IEC 60904-7) it can be estimated through outdoor/indoor comparison measurements of reference and test device. For that purpose, the ratio of short circuit currents recorded at natural sunlight (blue sky conditions, diffuse irradiance <30%, zenith angle of the sun <42°) and simulated sunlight can be taken as estimate. At present however there is no consen-

sus on the trade-off between small area, matched devices and large area unmatched devices for which the influence of non-uniformity effects has not been clarified.

- As the electrical performance of thin-film modules can be subject to a considerable spread (fabrication tolerance), care must be taken when using a fixed spectral mismatch factor. If required, a range of spectral mismatch factor should be determined for thin-film modules of different efficiency classes. It should also be borne in mind that the spectral mismatch factor is influenced by spectral irradiance. In this regard, the change of the solar simulator lamp spectrum with operating time must be considered.

Solutions for three broad thin-film technology classes are discussed below.

Amorphous Silicon

For a-Si it is generally recommended to use a c-Si reference device with a filter (such as KG1 glass) to mitigate spectral mismatch effects. This is particularly relevant when testing on pulsed solar simulators, especially those using a decaying pulse. Ideally the filtered device has all the desired properties of a c-Si reference (mainly stability, as long as the filter is stable against time and irradiance). Different filters can be used, ranging from “strong” (giving the narrowest SR) through medium to “weak”, giving the widest SR range (Figure 14). Any of these filters match the SR of a-Si better than c-Si does, thereby reducing the spectral mismatch. But even in the case of apparent match between SRs, the spectral mismatch can remain significant (several %) and therefore should be determined and corrected for in each measurement.

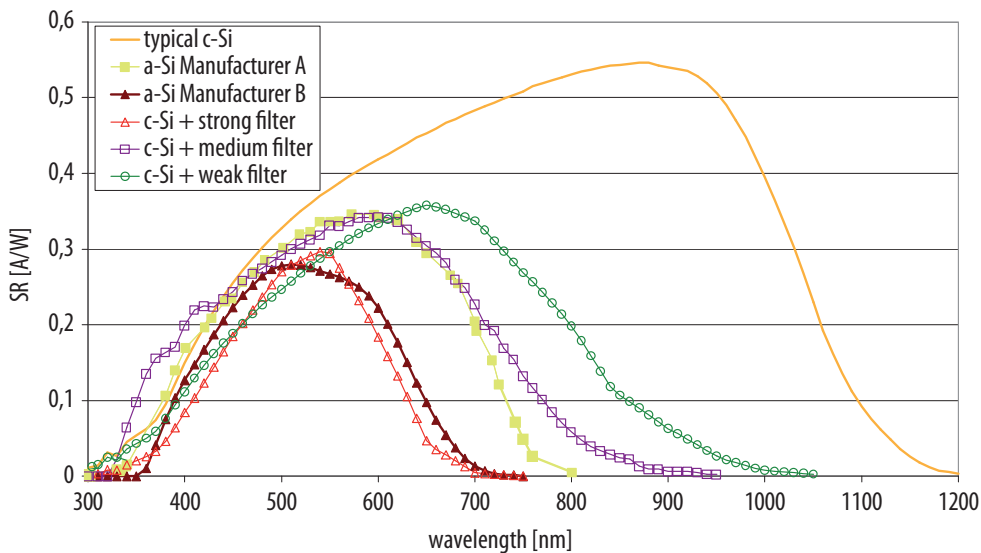

Figure 14: Spectral response of a-Si from two manufacturers in comparison with c-Si and filtered c-Si cells; the SR of the manufacturer A device is best matched by a medium filter, whereas for the manufacturer B device the strong filter is more appropriate.

Reference devices based on c-Si with added filter would not normally be primary references, but secondary or working references. As such they would be calibrated against a c-Si primary reference. This calibration provides the traceability chain and needs to include a spectral mismatch correction. Concerning storage, handling, calibration and traceability, a filtered c-Si reference device should be treated as any reference device, as described in IEC 60904-2.

One possibility relevant to production control is a-Si device that is only used indoors, is stored at constant (room) temperature in the dark and only exposed to light from pulsed solar simulators. Such a device might be considered as stable and could therefore potentially be a reference, but strict conditions would have to be obeyed, namely control of storage temperature and cumulative irradiance. Furthermore it should never be exposed to natural sunlight, which excludes its use during outdoor measurements and excludes its calibration with an outdoor method. The re-calibration interval should be significantly shortened compared to c-Si reference devices and possibly it should be stabilized before each calibration by the procedure in IEC 61646.

Cadmium Telluride

Like other thin film materials CdTe itself is not considered suitable for use in a reference device on account of its sensitivity to light soaking effects. One approach is to use a GaAs device, which has a similar band gap to CdTe. In fact the measured mismatch is small, as is evident from the data in Table 4. Making a GaAs module capable of fulfilling the requirements of IEC 60904-2 is however not a practical proposition. A solution may be to use such a spectrally well matched reference cell to verify the stability of a CdTe working reference module. Possible changes in its SR could be detected using the procedure described above. This would give the advantages of an optically and resistively matched module, provided the stability can be controlled to a level comparable to c-Si. An alternative is to use c-Si reference cells with a filter. The required spectral characteristics of such a filter are shown in Figure 15. Such filters are not generally available off-the-shelf, but could be developed for specialised requirements. In any case the long term stability of such filters needs to be verified.

Table 4: Measured mismatch between GaAs reference devices and test devices in CdTe and c-Si using Class A and Class C simulator spectra.

Simulator spectrum	Reference device material	Test device	Mismatch factor
Class A	GaAs	CdTe 1	1.004
Class A	GaAs	CdTe 2	1.005
Class A	GaAs	CdTe 3	1.004
Class A	GaAs	CdTe 4	1.004
Class A	GaAs	Si	1.031
Class C	GaAs	CdTe 1	0.953
Class C	GaAs	CdTe 2	0.984
Class C	GaAs	CdTe 3	0.962
Class C	GaAs	CdTe 4	1.016
Class C	GaAs	Si	1.307

CIGS

CIGS devices should not be used for as references due to their inherent material instability. Investigations of long term dark storage have shown variations in I_{sc} of about 2.5%, dependent on the condition used. Instead it is possible to select a c-Si reference module with a very low spectral mismatch to CIGS (Figure 16). Of course the spectral quantum efficiency of CIGS devices is sensitive to the exact composition and a variation of production parameters may result in a device requiring a different c-Si reference.

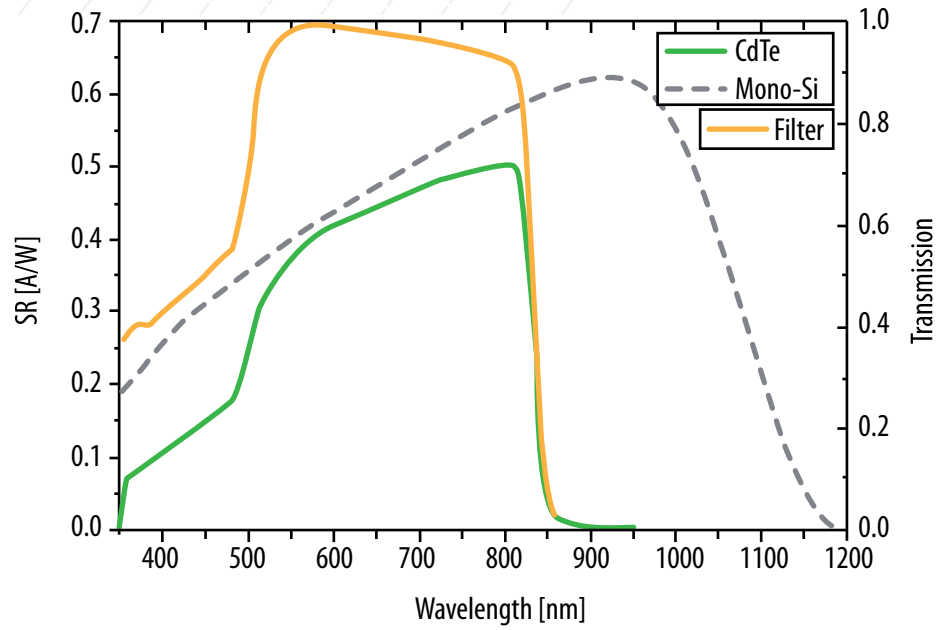

Figure 15: Spectral response of a CdTe-device compared to the one of a c-si cell filtered using an ideal filter curve

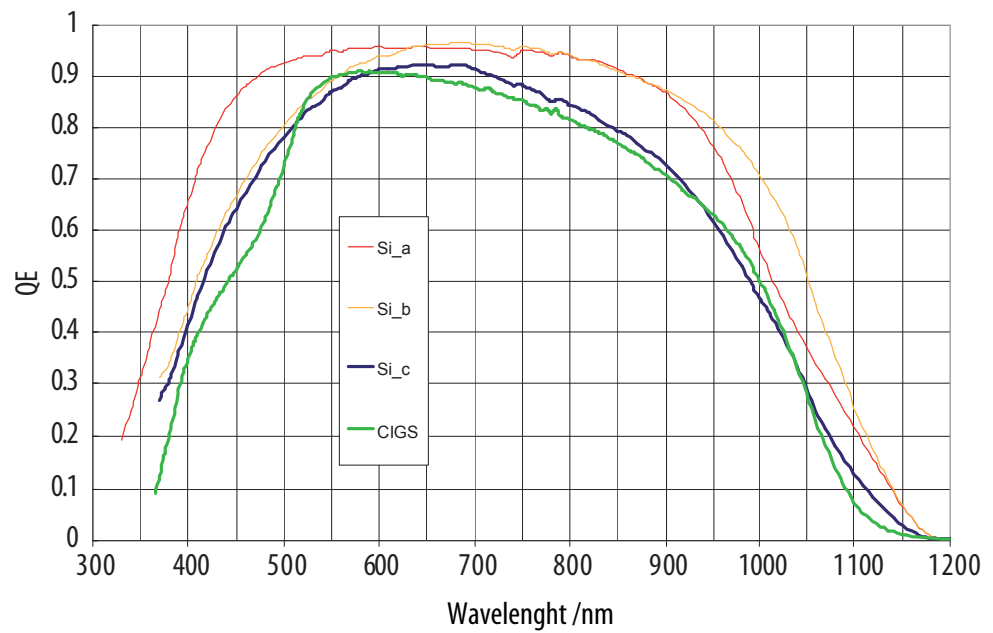

Figure 16: Spectral quantum efficiency of CIGS and different Si cells, indicating the suitability of the latter to be used as for reference devices for calibration of CIGS modules.

5.3 Multi-Junction Thin Film Modules

This section addresses module technologies based on multi-layer a-Si or a-Si combined with a nanocrystalline or “micromorph” layer. The main feature of such devices is that they are composed of layers connected both optically and electrically. These layers are typically grown monolithically on a substrate and interconnected with tunnel diodes. The optical series (stacked) connection allows simultaneous use of different band gap materials for the sub-cell absorbers (layers) so as to optimise response to the incoming irradiance. On the other hand the electrical series connection means the current is limited by the sub-cell with the lowest photocurrent for the whole device under the prevailing spectral and irradiance conditions. A major challenge for calibration of multi-junction modules for a testing laboratory is that it is generally not known a priori which layer or sub-cell is current limiting at STC, whereas for measurements at a manufacturer this information is likely to be available. At present there is no IEC standard for calibration of multi-junction cells or modules, although ASTM E2236 [21] does address some aspects. The following sections aim to provide guidance on the measurement options available, focussing on the key issues of spectral mismatch and reference devices. It is noted that pre-conditioning in principle follows the recommendations made for a-Si modules in section 5.2.3, while capacitive effects are judged medium i.e. a sweep time of greater than 10 ms is desirable.

5.3.1 Spectral Mismatch

Two approaches are currently being used to address the fact that, for series-connected multijunction devices, all IV-parameters depend on the photocurrent ratio of the individual sub-cells.

a) Constant photo-current ratio approach

This approach is based on the assumption that for a precise measurement of the total current of a MJ device at STC, the same photocurrent ratio for the sub-cells or layers must be reached under the simulator as under the standard spectrum. The photocurrent ratio is expressed as:

$$\frac{I_{SIM}^{top}}{I_{SIM}^{bottom}} = \frac{I_{STC}^{top}}{I_{STC}^{bottom}} = K \quad (5)$$

where: $I_{SIM,STC}^{top,bottom} = \int SR_{top,bottom}(\lambda) \cdot E_{SIM,STC}(\lambda) d\lambda$ and $I_{SIM,STC}^{top,bottom}$ is the short circuit

current of the top/bottom cell under the simulator/standard spectrum. If the sub-cells or layers are current matched for the standard spectrum the ratio is $k = 1$. Assuming the relative spectral responses of the sub-cells are known or can be measured [27, 26] and with the condition that each sub cell produces the same current under the simulator as for the reference spectrum,

$$I_{SIM}^j = I_{STC}^j \quad (6)$$

a linear equation system holds.

$$\sum_k A_k \int sr_j(\lambda) e_k(\lambda) d\lambda = \int sr_j E_{STC}(\lambda) d\lambda \quad (7)$$

Where $e_k(\lambda)$ are the relative spectral distributions of k individual lamp sources. Solving this system results in solutions A_k for the lamp power adjustment in a multi-lamp simulator.⁷ With these the different lamp sources can be adjusted so that a suitable reference cell with spectral response SR_{RC} irradiated with the partial spectrum $e_k(\lambda)$ delivers the current:

$$I_k^{RC} = A_k \int SR_{RC}(\lambda) e_k(\lambda) d\lambda \quad (8)$$

This method is used at ISE to measure multijunction solar cells on small areas of about $4 \times 8 \text{ cm}^2$. Similar methods are used for larger areas at AIST [28].

b) Limiting Cell Mismatch Correction Approach

In this approach [29] a single light source (either natural sunlight or an indoor simulator) is used for the power measurement, with the precondition that the limiting cell/layer of the module should be the same as that under STC conditions⁸. IEC 60904-7 describes the procedure to correct the error introduced due to the mismatch between the test spectrum and the reference spectrum and that between the spectral responses of the reference cell and of the device under test. In the case of a tandem module the SR of the two sub-cells is measured in turn by illuminating the with an appropriate coloured bias light to saturate the response one of the sub-cells, allowing measurement of the SR of the other (now current limiting) sub-cell. The mismatch factor (*MMF*)⁹ is given by:

$$MMF = \frac{\int SR(\lambda) E_{AM1.5}(\lambda) d\lambda}{\int SR(\lambda) E_L(\lambda) d\lambda} \cdot \frac{\int SR_{ref}(\lambda) E_L(\lambda) d\lambda}{\int SR_{ref}(\lambda) E_{AM1.5}(\lambda) d\lambda} \quad (9)$$

where $SR_{ref}(\lambda)$ is the spectral response of the reference cell used.

In the case of a multijunction device the spectral mismatch correction is made with the MMF value for the current limiting junction under the irradiance conditions used for the I-V measurement. Using Equation 6, the MMF values for each of the cells, top and bottom, are obtained by using the spectral irradiance distribution $E_L(\lambda)$ of the simulator, or of the natural sunlight, and the spectral response (SR) of the limiting sub-cell. Ultimately the MMF value of the limiting junction is used for calculating the corrected I-V characteristics for the module, which take account the spectral mismatch to the $E_{AM1.5}(\lambda)$ spectral distribution.

⁷ Using a single source simulator with adjustable filtering and intensity would offer another possibility to adapt the spectral irradiance; however a patent protects the use of movable filters for the adjustment of the spectral irradiance of a solar simulator and thus its use in a standard is not an option.

⁸ This information may be available from the manufacturer or must be established based on spectral response measurements on the module itself or a sub-module or cell with an identical manufacturing route and physical characteristics.

⁹ $MMF = 1/MM$ as defined in the IEC standard due to historical reasons. However, the final results are identical

It is possible to determine the limiting junction from the spectral response measurements. This is done by calculating first the short-circuit current I_{sc} for each junction, top and bottom, from the following equation

$$I_{sc} = nA_{test} \int SR(\lambda) E_L(\lambda) d\lambda \quad (10)$$

where n is the number of cells, A_{test} is the cell area, $E_L(\lambda)$ is the spectral irradiance of the simulator where the I-V measurements are performed, and $SR(\lambda)$ is the spectral response of each junction cell. The I_{sc} values obtained from equation (10) have to be multiplied by a scaling factor,

$$SF = \frac{I_{sc}^{meas}}{\min I_{sc}} \quad (11)$$

which is defined as the ratio of the measured I_{sc} from I-V measurements to the minimum I_{sc} calculated from equation (10). This scaling is necessary since equation (10) uses the relative spectral response of each junction instead of the absolute one. The smaller short-circuit current value obtained after the scaling determines the limiting junction.

An important assumption throughout this procedure for correcting the measured I-V parameters of a multi-junction module using the MMF is that the limiting junction has to be the same under the standard spectral irradiance as defined in IEC-60904-3 and under the I-V measurements. In case where the spectral difference of the simulator and AM1.5g is too large, the current-limiting junction may be different under each measurement and consequently the mismatch correction would refer to the short-circuit current given by a different junction. A measurement and spectral mismatch correction with a different solar simulator should be done in this case.

5.3.2 Reference devices

Using a multijunction module from production appears not suitable. Apart from considerations of stability, if the different junctions are approximately current matched, any shift in spectral irradiance may shift the current matching point between sub-cells i.e. change the limiting sub-cell.

For reference cells there are different possibilities. The first is to use a reference with a wide spectral response range that covers the whole spectral response range of all multijunction sub cells. A crystalline silicon solar cell is often appropriate. The advantage is clearly the availability in each laboratory of a well-calibrated and stable reference. The disadvantage lies in the quality of spectral match to each sub cell, which may be poor. The second possibility is to use an individual spectrally matched reference for each sub cell. This leads to a longer and more elaborate measurement procedure in practice. For cell technologies which produce cells with stable properties over time customised “component” cells are advantageous. These have the same structure as the multijunction cells with all absorbing layers but only one pn-junction.

If such specially made cells are not sufficiently stable or are not available, filtered silicon solar cells are a good alternative. Due to the different technologies on the market for thin film multijunction modules several kinds of filtered reference cells are necessary. On the other hand, the design of a filtered reference cell with specific spectral properties is a difficult task and depends on availability and stability of filters.

At present the only viable compromise appears to be the use of a c-Si module to set/control the irradiance intensity, in spite of the high spectral mismatch.

A further factor to consider for multi-junction thin-film devices is that current mismatch between the junctions may be different for the spectral irradiance during IV measurement compared to that under the standard AM1.5 spectrum. Care should be taken as this effect can cause excessive measurement errors, also of fill factor. Depending on the characteristics of the solar simulator (adjustment range of lamp power, distance of lamp to test area, optical filters etc.) the effective irradiance for thin-film modules can lie considerably below or above 1000 W/m^2 so an irradiance correction of the measurement is required. A low uncertainty related to irradiance correction assumes that the correct module parameters are used. These can be different for thin-film modules of different efficiency class and should be carefully evaluated.

6. Traceability and Uncertainty

6.1 Basic Considerations

A prime requirement for each reliable measurement conveying a legal validity is that there is an unbroken traceability chain to an international primary standard and a documented uncertainty calculation for each transfer step in the chain. The traceability chain for the measurement of IV characteristics of PV modules of all laboratories participating in IP Performance was analysed and evaluated in D1.4.1 “Actual practise and deficiencies of PV calibration traceability”. Part of the documentation of an unbroken traceability chain is an analysis of the measurement uncertainties in each calibration transfer from primary standards down to PV modules. The uncertainty calculations in the participating laboratories was examined in D1.4.2. “Principles of uncertainty analyses and evaluation of the traceability chain”. In these guidelines the main points are summarised and the implications for industry PV measurements addressed.

6.2 Traceability

The measurement of IV characteristics of PV devices involves a number of measurements, such as voltage and current at the module, temperature and irradiance. All of these (except the last) are well established measurements, which are not specific to PV. There are numerous calibration services available, and establishing a traceability chain for these measurements does not pose any particular problem. As far as irradiance is concerned, however, the situation is much more complex.

The prime objective of a PV reference device is to measure the irradiance level of around 1000 W/m² of the (simulated) sunlight. For reasons of similarity of devices (minimizing the spectral mismatch) and the response time required on pulsed solar simulators, PV reference devices are used for the irradiance measurements in laboratories and industry.

The traceability chain of PV irradiance sensors has been recently published in IEC 60904-4. This standard describes the traceability chain from international primary standards for irradiance to PV reference devices. It proposes possible methods for the most crucial transfer in the chain, namely the calibration of primary PV reference cells against international standards for irradiance, including an indication of uncertainty budget. The further transfer between different PV reference devices is covered by IEC 60904-2.

Historically the World Photovoltaic Scale [33,34,35] was established. It inter-compared different transfer methods from international irradiance standards to PV devices. In the 1990s the spread in the data was considerable leading to a final combined expanded uncertainty U95% (k=2) of ±1.9% for the calibration value of the

primary PV reference cells. Further efforts since 2000 have improved the situation. A preliminary analysis of some of the data has shown that the spread between calibration methods using different traceability chains has been reduced to about $\pm 1.0\%$ (U95%).

According to IEC 60904-4 the traceability for solar irradiance sensors requires to tie the calibration value to SI units in an unbroken and documented chain of calibration transfers including stated uncertainties. This means that any instrument required and used in any transfer procedure also has to be an instrument with an unbroken traceability chain to the respective SI unit. An explicit and detailed uncertainty analysis is required for each transfer step. Repeatability should be documented, either through a laboratory quality control system or by inter-comparison to other laboratories. There should also be inherent precision due to a limited number of intermediate transfers (a permissible number of transfer steps is not given). It should be mentioned here that within the European Union, all quantities which influence a commercial value must be based on an unbroken chain of transfers to SI units.

6.3 Measurement Uncertainty

These guidelines are intended to provide a general introduction to measurement uncertainty for the determination of electrical characteristics of PV devices. The main factors to consider when determining the performance from a measurement of the current-voltage (IV) characteristics of PV modules are presented. A full uncertainty calculation needs to be performed for each measurement procedure, the instruments used and the subsequent data analysis. As this requires detailed information and is specific to each laboratory, such a calculation is beyond the scope of these guidelines. An example of such a detailed analysis at a reference laboratory has been published recently [36].

6.3.1 Contributing Factors

In the determination of electrical performance of PV modules a number of measurements are taken and conditions applied, all of which have an influence on the final result and its uncertainty. The main groups are uncertainties related to electrical measurements, temperature and optical effects, the reference device and the connections (cabling). Furthermore there are contributions from any step of data analysis and last not least there might be (significant) contributions from the preconditioning, instability and response of the PV device itself. The latter are beyond the scope of these guidelines, but should be considered before doing any measurement as potentially their effects might be larger than any other component contributing to uncertainty. Table 5 shows the main groups and associated contributions that might be considered.

Table 5: Factors to be considered in uncertainty analysis.

Parameter	Items to be considered
Electrical uncertainty	<ul style="list-style-type: none"> – Data acquisition (I and V) – Shunts for current measurement – Irradiance measurement from reference device
Temperature uncertainty	<ul style="list-style-type: none"> – Indicators – Measurement condition with respect to STC – Temperature non-uniformity in test device
Optical uncertainty	<ul style="list-style-type: none"> – Spatial non-uniformity of irradiance in the target plane – Orientation of reference and device under test with respect to optical axis – Alignment of reference and device under test with respect to each other
Reference device uncertainty	<ul style="list-style-type: none"> – From calibration certificate – Reference cell drift (since last calibration)
Fill Factor uncertainty due to connection/cabling	
Repeatability	<ul style="list-style-type: none"> – Within one set of measurements – Periodic measurements on a stable sample including “system drift”
Data analysis	<ul style="list-style-type: none"> – Correction to reporting conditions (normally STC) – Irradiance – Temperature – Spectral mismatch

6.3.2 Calculation Principles

The principle of the uncertainty calculation is to look at all measured variables (measurands) and conditions which contribute to the final measurement result. For each variable a measurement uncertainty has to be established and the transfer to the final uncertainty calculated based on the component's contribution to the final measurement result.

The uncertainty of a measurement is normally expressed as an interval around the given result and the probability of finding the true value within that interval. The probability is also called confidence level. For a Gaussian distribution an interval of $\pm\sigma$ (standard deviation) gives a confidence level of 68.3%, whereas $\pm 2\sigma$ corresponds to a confidence of 95.4%. The most widespread confidence level is U95% (giving 95% confidence) corresponding to two standard deviations or a coverage factor $k = 2$ (strictly speaking $k = 1.96$ for U95% and a Gaussian distribution). A single standard deviation ($k=1$) is also called standard uncertainty whereas the expanded uncertainty corresponds to U95% ($k=2$). In order to combine the uncertainties associated with different measurement variables they all have to be on the same confidence level and distribution, commonly standard uncertainties with Gaussian distribution. For confidence distributions which differ in shape from a Gaussian distribution, a correction factor is applied. If the variables are independent, the combined standard uncertainty can be calculated as the geometrical mean of all single components (i.e. the square root of the sum of squares). Otherwise the correlation has to be taken into account. The combined standard uncertainty is then multiplied by the coverage factor (i.e. $k=2$ for U95%) to obtain the combined expanded uncertainty. It is often easiest to calculate the uncertainties as percentage of measurand and quote the combined expanded uncertainty also as such. Through multiplication with the measurement result it can easily be transformed into absolute values with the same units as the measurand.

A number of required parameters will normally be provided from external sources, for example the calibration value and its uncertainty for the reference device. As long as the conditions for traceability are fulfilled these values can be used as input. Other parameters depend on the measurement procedure and condition and have to be evaluated and determined in each laboratory.

As the combined uncertainty is calculated as the square root of the sum of squares of all components, it can be reduced mainly by reducing the major components, whereas a reduction of a minor component might not be visible in the combined uncertainty. Hence a detailed uncertainty analysis is also useful as indication which parts of the measurement procedure and conditions are critical and should be well controlled or improved. Any measurement result needs to be quoted not only as value and unit but the uncertainty interval and its confidence level with it. Without these a measurement result has no formal validity.

From an analysis of the measurements in the laboratories participating in Performance IP it emerged that the combined expanded uncertainty of the maximum power of PV modules was between 1.6% and 3%. The electrical and temperature related uncertainty contributions were negligible, whereas those originating from optical, reference cell and spectral mismatch correction were the major contributors to the final result:

- The optical uncertainty arises when laboratories transfer the irradiance value from a (small) reference cell to a (much larger) PV module. In such a case the contribution of spatial non-uniformity is significant, even for class A simulators.
- The uncertainty associated with a reference cell is linked to its traceability.
- For the spectral mismatch, the uncertainty is linked to the complexity of its determination, since it requires the SR of the reference device, the SR of the PV module (not easily obtained) and more importantly the spectral irradiance distribution of the solar simulator.

In industry the reference device would normally be a module calibrated by a reference laboratory, with a stated uncertainty which could be used in subsequent uncertainty analysis as an input parameter. In such a case the effects of spatial non-uniformity and spectral mismatch would then become negligible.

6.4 Good Practice

Traceability

All measurement instruments require a periodic, traceable calibration, duly documented with a calibration certificate. The certificate should be issued by an ISO 17025 accredited laboratory and should include measurement uncertainty and demonstration of traceability. Special attention should be given to the reference irradiance sensor, as it is one of the most critical components in the determination of electrical performance of PV devices.

Reference devices:

As discussed in previous sections, there are various considerations to be made in choosing a PV reference device. However in the present context the only requirement is traceability. For almost all laboratories the traceability chain of the reference device will be provided by an external organisation in the form of the calibration (including calibration certificate with stated uncertainty). For the receiving laboratory this will be the highest available reference and the number of such devices in any laboratory will be limited. The use of these references in daily work will minimise uncertainty, but brings the risk in case of damage during handling or degradation due to frequent use. Therefore it is common to transfer the calibration to working references for daily use and keep the higher level reference stored safely. This requires an in-house procedure for the calibration transfer according to the criteria outlined above. This might seem to be an extra burden, but such procedures (including traceability and uncertainty calculation) need to be in place for measurements anyway (at least for the transfer between nominally identical devices).

The periodic recalibration of reference devices should be foreseen, both for the calibrations by external organisation and those performed in house.

The reference device can be a PV cell or module. For industry the choice of a reference device of same size and technology to the PV devices to be measured is preferable. The reference needs to be stable, handled and stored with care and regularly checked, also in the periods between the periodic recalibrations.

Uncertainty

- A detailed uncertainty analysis of the implemented measurement procedure needs to be elaborated.
- The determined uncertainties also need validation. One possibility is an inter-comparison with other laboratories. Another is the repetition of the same measurement at one laboratory. For this there are various possibilities, such as making several consecutive measurements without any change, disconnecting the PV module in between measurements, changing instruments and reference device, repeating on different days and with different operators. Based on the variations observed between such repeated measurements, a specific uncertainty just for the reproducibility can be verified for those components in the uncertainty calculation which were varied between the measurements.
- To improve the uncertainty, the major components identified in the uncertainty calculation should be addressed.
- It is always best to measure near the reporting conditions, normally STC. Any correction introduces additional uncertainty, since in most cases these vary proportionally. Data analysis and correction procedures should follow international standards, and their implementation needs to be documented and validated.
- The solar simulator used for the measurements should be characterized after installation and at regular intervals, keeping in mind that also a class AAA simulator still might require explicit correction of measured IV characteristics as per IEC 60891.
- All measurements and data analysis should only be entrusted to trained operators.
- Control measurements to verify the measurement set-up and the reference devices should be performed regularly, as well as the comparison in inter-comparison with external laboratories.
- Characteristics of the device under test (stability, dependence on pre-conditioning and possible sweep speed effects on pulsed solar simulators) need to be assessed before making a performance measurement, because potentially they are larger than any measurement uncertainty.

7. Quality Control and Data Handling

7.1 General Measures

Performance measurements should be conducted in the framework of an organisational system that promotes a culture for high precision, reliable data. This is often realised in a quality management system i.e. one which embodies the principles of a “plan-do-check-correct” philosophy, with regular auditing and improvement/corrective measures. Key features typically include:

- Clear and documented definition of the procedures and responsibilities, typically involving a hierarchical system of implementation and monitoring.
- A well-organised procedure for documenting the work on each test station; for this it is common to use operation and maintenance logbook divided into daily, weekly, monthly and annual reporting units in order to track the regular technical checks, the reproducibility checks, the sensor states, environmental conditions, changes or adjustments to the solar simulators, etc.
- Tightly controlled use reference devices
- Systematic approach to ensuring the traceable calibration of all temperature, radiation and voltage sensors, and organization and control of compliance with the appropriate calibration intervals. The implementation of the calibration itself shall be documented.

7.2 Training

- The personnel performing measurements should have an adequate level of training, relating both to photovoltaics and to measurement technology itself and should be reinforced by a recognised programme of continual professional development.
- The level of training and preparation of the personnel should comply with the requirements foreseen by the manufacturer of the measuring equipment. It makes sense to ensure an intensive interaction between the equipment manufacturer and testing staff on site to optimise operation. The equipment setting and software parameters should be documented for the various reference devices and production module types.
- Participation to internal or external intercomparison exercises can be extremely useful both to optimise procedures and to ensure that a high level of measurement quality is maintained.

- Attention should also be given to establishing a good understanding of the procedures used to correct measurement data to STC conditions (temperature and radiation) at the maximum power point, rather than relying on a “black-box” approach. For instance when alternative correction procedures are foreseen in standards, selection of appropriate methods for a specific technology relies on proper staff training, as errors can have significant consequences.

7.3 Measurement Uncertainties

Quantification of uncertainty is a requirement for calibration measurements. It is critical for all power measurements systems to gain a proper understanding of the influence of factors such as reproducibility, sensor uncertainties for temperature and radiation, uncertainty in data acquisition and uncertainty in corrections to STC. This is a key tool to identifying weaknesses and implementing the improvement needed to raise overall data reliability.

7.4 Data archiving production documentation

The goal should be a comprehensive organization of the input and output data, including IV data, temperature and irradiance values, module identification data, reference device and system settings for each measurement. It is recommended that such information is stored in both processed and non-processed forms.

8. Summary and Recommendations

Precise and reliable power measurements are essential to the PV industry and to investors. These “PERFORMANCE Project Guidelines” present current best-practices for determination of maximum output power at standard test conditions (as opposed to the operating conditions). Particular attention is given to emerging technologies, such as high efficiency silicon and thin-film, which have high potential but also require adaptations of the measurement procedures already standardised for crystalline silicon devices.

Crystalline silicon modules

Procedures for output power characterisation are already extensively addressed in IEC and EN standards. Intercomparisons between specialised laboratories show that repeatability is within $\pm 2\%$, which corresponds approximately to the level of measurement uncertainty. Industrial practices for measurements can however be less reliable. Issues highlighted by these guidelines include:

- Quality of the light source: this is often at the root of deviations in measurement accuracy; recommendations for solar simulators include:
 - Use of class AAA simulators, typically equipped with xenon flash lamps
 - Document spectral irradiance and uniformity in the test area.
 - Regular performance checks
 - Effective irradiance close to 1000 W/m^2 to keep the irradiance correction low.
- I-V measurements: while the electronic load equipment is frequently provided by the equipment manufacturer, close attention is needed to the temperature control of the module and to the connections. For STC measurements modules from production shall be given sufficient time to adjust to ambient, bearing in mind that the P_{MAX} error is approximately 0.5% per $^{\circ}\text{K}$. The uniformity of the temperature distribution shall be verified, and a minimum 2 temperature sensors shall be used. Cable adapters shall be regularly checked and replaced as frequent use to connect modules to the 4-wire input terminals of the I-V load will cause deterioration of the terminals/clamps.
- Reference modules should respect the criteria set out in IEC 60904-2, with respect to size, stability, handling and storage. Special attention is required for the connections, as standard PV elements are not designed for repeated use. Adjustments of solar simulators with a reference module may use I_{SC} or P_{MAX} as a calibrating parameter; there are pros and cons to either but in general all performance parameters (P_{MAX} , I_{SC} , V_{OC} , FF) should be within $\pm 1\%$.
- Traceability and uncertainty: for measurements with legal validity an unbroken traceability chain to an international primary standard is required and a documented uncertainty calculation.

High efficiency silicon modules

High efficiency c-Si modules – in the form of either back contact or HIT cells – are usually highly capacitive and power measurements can be influenced by sweep-time effects when the IV scan acquisition times are too fast (generally already below 200 ms). The capacitive characteristics depend on the specific technology and for calibration purposes the appropriate I-V sweep speed needs to be established experimentally, usually by performing a sweep in both directions. Outdoor measurements can avoid these issues by using very slow sweeps e.g. 1 second duration. For flash simulators use of long-pulse or multi-flash methods can be considered.

Thin film modules

While as yet there are no specific calibration standards for thin film modules, current “good practice” is summarised below for four generic technology areas: a-Si, CdTe, CIS and multijunction devices. It is however stressed that the performance of a given module type can be sensitive to the specific chemical composition and to the manufacturing and conditioning history. Recent intercomparisons between specialised laboratories indicate that repeatability on P_{\max} is at the level of $\pm 5\%$, although the individually quoted levels of uncertainty may be less than this.

- Amorphous silicon modules:
 - Pre-conditioning: light soaking is required to reach a stabilised state, using a procedure such as that in the IEC 61646 standard. However since this allows a wide range of module temperature (40-60°C), it should be verified that the conditions used are adequate to achieve a state representative of the expected operational temperatures.
 - Reference devices: filtered crystalline cells are recommended to minimise spectral mismatch while maintaining high stability. For production references, it may be possible to use amorphous silicon modules provided these are stored in the dark at ambient temperature or below, and their light exposure is minimised.
 - Capacitive effects are considered to be at a medium level and appropriate checks on sweep speed need to be made.
- Cadmium telluride modules:
 - Pre-conditioning: after production or after periods stored in the dark, CdTe modules require light soaking to bring performance up to the level expected in operation.
 - Reference devices: filtered crystalline cells are recommended, but CdTe modules may be used as production references if their stability can be cross-checked with appropriate reference cells.
 - Capacitive effects are considered to be low, so flash and sweep times as for crystalline silicon can be used.

- CI(G)S modules:
 - Pre-conditioning: a light soaking procedure is required but care must be taken to minimise the time between the light soaking and flash simulator measurements due to the sensitivity of these devices to short term dark ageing effects; for calibration measurements a constant simulator or outdoor measurement set up may be preferable.
 - Reference devices: it is recommended to use c-Si reference module with a very low spectral mismatch to the device being tested.
 - Capacitive effects are considered to be low, so sweep times as for crystalline silicon can be used.
- Multi-junction modules (typically tandem/triple a-Si, a-Si/ μ c-Si)
 - Pre-conditioning: similar procedures as for amorphous silicon can be applied, with adequate checks that stability is reached.
 - Spectral mismatch correction: the spectral response of the two layers must be established to allow correction to STC conditions; this is a non-trivial undertaking.
 - Reference devices: filtered crystalline cells are recommended to minimise spectral mismatch while maintaining high stability.
 - Capacitive effects: considered to be medium and appropriate checks on sweep speed need to be made.

Finally, it is stressed that the quality of any power measurements is based on the use of appropriate and calibrated equipment operated by well-trained staff, in the framework of an organisational system that promotes a culture for precision.

9. References

1. E. D. Dunlop, W. Zaaiman, H. A. Ossenbrink, C. Helmke, "Towards a stable standard reference device for the measurement and monitoring of amorphous silicon modules and arrays" Proc. 14th EU PVSEC, Barcelona, 1997 p. 1632-5.
2. S. Roschier, W. Zaaiman, E. D. Dunlop, D. Bonnet, B. Dimmler, R. Menner, J. Sherborne, E. Skarp, "Calibration and measurement techniques for thin film modules" Proc. 2nd World PVSEC, Vienna, 1998, p. 676-9.
3. S. Winter, J. Metzendorf, K. Emery, F. Fabero, Y. Hishikawa, B. Hund, H. Müllejans, A. Sperling, W. Warta, The results of the Second World Photovoltaic Scale Recalibration, Photovoltaic Specialists Conference, 2005. Conference Record 31st IEEE, 2005, p. 1011.
4. S. Mau, Influence of Solar Cell Capacitance on the Measurement of I-V-Curves of PV-Modules, Proc. 20th EUPVSEC, 2005.
5. A. Virtuani, H. Müllejans, F. Ponti, E. Dunlop, Comparison of indoor and outdoor performance measurements of recent commercially available technologies, Proc. 23rd EU PVSEC, WIP-Renewable Energies, 2008, 2713-2718.
6. Monokroussos, C.; Gottschalg, R.; Tiwari, A.N.; Friesen, G.; Chianese, D.; Mau, S, The Effects of Solar Cell Capacitance on Calibration Accuracy When using a Flash Simulator, Conference Record IEEE 4th World Conference on Photovoltaic Energy Conversion, Volume 2, 2006, pp 2231 – 2234.
7. R.A. Sinton, Flash testing high-efficiency silicon solar cells and modules, Proc. 20th EU PVSEC, 2005.
8. PERFORMANCE Deliverable D1.3.4 "Summary report on back contact cell technology measurement", ISE FgH, 2008.
9. Cuevas, A., Recart, F. Capacitive effects in quasi-steady-state voltage and lifetime measurements of silicon devices, (2005) Journal of Applied Physics, 98 (7), pp. 1-7.
10. W. Herrmann, K. Kiefer: Cluster-Projekt Charakterisierung von PV-Modulen, 2. Workshop Photovoltaik-Modultechnik, Köln, 1./2. Dezember 2005.
11. Kiefer, K.; Warta, W.; Hohl-Ebinger, J.; Herrmann, W.; Heisterkamp, N., Optimisation of the Power Measurement of Silicon Photovoltaic Modules, Proc. 21st European Photovoltaic Solar Energy Conference, Dresden, WIP-Renewable Energies.2006.
12. A. Virtuani, D. Pavanello, R. Kenny, M. Nikolaeva-Dimitrova, and E. Dunlop, Outdoor Module Performance of Single, Double and Triple-Junction Silicon Based Thin Film Technologies, Proc. 22nd EU. PVSEC, (Milan, 2007), WIP-Renewable Energies, 2421-2426.
13. R. Kenny, M. Nikolaeva-Dimitrova and E. Dunlop, Performance Measurements of CIS Modules: Outdoor and Pulsed Simulator Comparison for Power and Energy Rating, Conference Record of the 2006 IEEE 4th World Conference on Photovoltaic Energy Conversion, p. 2058.
14. S. Roschier, E. Dunlop, Light Soaking of Amorphous Silicon, CdTe and Cu(In, Ga)Se₂ Samples, Proc. 16th EU-PVSEC, (Glasgow, 2000).

15. Staebler D, Wronski C, Reversible Conductivity Changes in Discharge-Produced Amorphous Si, *Appl. Phys. Lett.* 31, 292 (1977).
16. G. Cereghetti, N., Chianese, D., Rezzonico, S., Travaglini, G., 2000. Behaviour of triple junction a-Si modules. In: Scheers, H., (Eds.), *Proceedings of 16th European Photovoltaic Solar Energy Conference*, Glasgow, UK, pp. 2414–2417.
17. M. Nikolaeva-Dimitrova, A. Skoczek, R. P. Kenny, E.D. Dunlop, Outdoor Module Performance of Single, Double and Triple-Junction Silicon Based Thin Film Technologies, *Proc. 23rd EU PVSEC, WIP-Renewable Energies, Munich (2008)* p. 2079-2083.
18. D. Willett and S. Kuriyagawa, The effects of sweep rate, voltage bias and light soaking on the measurement of CIS-based solar cell characteristics, *Proc. 23rd IEEE PVSEC*, 495-499, (1993), p.495.
19. First Solar Application Note PD-5-34 rev.1.0: Best Practice for Power Characterisation.
20. First Solar Doc. CP-3-210-010-W25: Pre-Conditioning of First Solar Modules Prior to Measurement of Performance at Standard Reporting Conditions.
21. ASTM E2236 “Standard Test Methods for Measurement of Electrical Performance and Spectral Response of Nonconcentrator Multijunction Photovoltaic Cells and Modules”.
22. U. Rau, and H.W. Schock, Electronic properties of Cu(In,Ga)Se₂ heterojunction solar cells-recent achievements, current understanding, and future challenges, *Appl. Phys.* A69, 131-147 (1999).
23. V. Ramanathan, L.A. Russell, C.H. Liu, and P.V. Meyers, Indoor Stability Tests on CdS/CdTe/ZnTe n-i-p Submodules Solar Cells, 28, 129, (1990).
24. D. Baetzner, A. Romeo, H. Zogg, R. Wendt, A.N. Tiwari, Development of efficient and stable back contacts on CdTe/CdS solar cells, *Thin Solid Films* 387 (2001) 151-154.
25. Wilkinson, V.A. and C. Goodbody, Measurement of Multijunction Cells under Close-Match Conditions, *Proc. 26th PVSC. 1997. Anaheim.*
26. Meusel, M., et al., Spectral Response Measurements of Monolithic GaInP/Ga(In)As/Ge Triple-Junction Solar Cells – Measurement Artefacts and Their Explanation. *Progress in Photovoltaics: Research and Applications*, 2003. 11: p. 499- 514.
27. J. Burdick, T. Glatfelter, Spectral Response and IV Measurements of Tandem a-Si Solar Cells, *Solar Cells*, 18 (1986), 301-314.
28. Hishikawa, Y., Y. Imura, and T. Oshiro, Irradiance and Wavelength Dependence of the I-V Characteristics of Solar Cells, in *12th International Photovoltaic Science and Engineering Conference (PVSEC-12)*. 2001, Korea. p. 129-130.
29. M. Pravettoni et al, “Spectral Response Measurements of Large Area Thin Film Multijunction Photovoltaic Modules at the European Solar Test Installation and Spectral Mismatch Calculation, *Proc. EU PVSEC, WIP-Renewable Energies, 2009.*
30. Adelhelm, R., Solar simulator with movable filter, US Patent 6590149, 2003.

31. ISO, GUM Guide to the Expression of Uncertainty in Measurement. 1995.
32. Osterwald, C.R. and e. al, The World Photovoltaic Scale: An International Reference Cell Calibration Program. Progress in PV, 1999. 7: p. 287-297.
33. C.R. Osterwald et al, "The world photovoltaic scale: an international reference cell calibration program", Progress in Photovoltaics 7 (1999) 287-297.
34. C.R. Osterwald et al, "The results of the PEP'93 intercomparison of reference cell calibrations and newer technology performance measurements: Final Report", NREL/TP-520-23477 (1998).
35. K. Emery "The results of the First World Photovoltaic Scale Recalibration", NREL/TP-520-27942 (2000).
36. H. Müllejans, W. Zaaiman, and R. Galleano, Analysis and mitigation of measurement uncertainties in the traceability chain for calibration of photovoltaic devices, Meas. Sci. Technol. 20 (2009) 075101.
37. H. Ossenbrink, A. Drainer, W. Zaaiman, "Errors in Current-Voltage Measurements of Photovoltaic Devices Introduced by Flash Simulators". 10th EU PVSEC, Kluwer, (1991), 1055.

European Commission

EUR 24359 EN – Joint Research Centre – Institute for Energy

Guidelines for PV Power Measurement in Industry

Author(s): N. Taylor (ed.)

Luxembourg: Office for Official Publications of the European Union

2010 – 88 pp. – 21 x 29,7 cm

EUR – Scientific and Technical Research series – ISSN 1018-5593

ISBN 978-92-79-15780-6

doi:10.2788/90247

Abstract

Precise and reliable power measurements are essential to the PV industry and to investors. These guidelines present current best-practices for determination of maximum output power at standard test conditions (as opposed to the operating conditions). Particular attention is given to emerging technologies, such as high efficiency silicon and thin-film, which have high potential but also require adaptations of the measurement procedures already standardised for crystalline silicon devices. The guidelines have been compiled by the members of the PERFORMANCE Integrated Project and represent the culmination of 4 years work, including round robin testing, reviews and surveys, as well as the partner organisations' extensive knowledge in this field.

How to obtain EU publications

Free publications:

- via EU Bookshop (<http://bookshop.europa.eu>);
- at the European Union's representations or delegations. You can obtain their contact details on the Internet (<http://ec.europa.eu>) or by sending a fax to +352 2929-42758.

Priced publications:

- via EU Bookshop (<http://bookshop.europa.eu>).

Priced subscriptions (e.g. annual series of the *Official Journal of the European Union* and reports of cases before the Court of Justice of the European Union):

- via one of the sales agents of the Publications Office of the European Union (http://publications.europa.eu/others/agents/index_en.htm).

The mission of the JRC is to provide customer-driven scientific and technical support for the conception, development, implementation and monitoring of EU policies. As a service of the European Commission, the JRC functions as a reference centre of science and technology for the Union. Close to the policy-making process, it serves the common interest of the Member States, while being independent of special interests, whether private or national.

