

Experimental Results of a Self-Learning Compensation System for High Precision Manufacturing

Marco Silvestri, Stefano Fontanesi, Marco Carnevale

Abstract: *This paper presents the experimental results obtained by applying the results of some recently concluded European projects, whose objective was the development and validation of hardware and control systems for production, based on understanding, evaluating and controlling the performance of a machine tool. It is based on a self-learning controller capable of managing a large quantity of data acquired by sensor systems, as well as on-board artifacts and finished work piece measurements that, associated to operating conditions, permit the accumulation of knowledge regarding the behaviour of machines. Relying on this experience-based approach, the controller can predict the errors that a machining process will present under different conditions and can thus adapt compensation tables. The approach set out has been implemented in a demonstrator consisting of a 5-axis high-precision boring machine, fully functional in an industrial shop floor but used under controlled environmental conditions (thermostatic chamber and special machine foundations). Its software system supports measurement procedures and is able to integrate data acquisition from different sensor systems, to calculate the volumetric error with 3D representations, to provide models for calculation of error functions and to integrate communication processes with the CNC. It can therefore operate in actual production sites, introducing relevant improvements in the machine tools manufacturing field. This paper presents the experimental results obtained during the project validation, including a comparison between on field measurements and compensation tables calculated on the basis of the predictions of the self-learning system. The analysis of the data gathered highlights the system's capability to deal with both simple linear dependencies (e.g. between error and mass variation) and complex, non-linear but repeatable trends. Results discussion, relating to two different and independent axis, demonstrates the applicability of the system under real operating conditions.*

Keywords: *Positioning compensation; machine tool performance; self-learning; boring machine*

I. INTRODUCTION

Large CNC machine tools for small or even single batch production require versatility, flexibility and a high level of accuracy [1]. Machine tools with dimensions in the order of meters are used indeed in different industrial sectors like

Revised Manuscript Received on September 2, 2019.

* Correspondence Author

Marco Silvestri*, Department of Engineering and Architecture, University of Parma, Parma, Italy and Department of Innovative Technologies, SUPSI, Manno, Switzerland. Email: silve@ied.unipr.it; ORCID 0000-0002-6651-2258

Stefano Fontanesi, Department of Engineering and Architecture, University of Parma, Parma. Email: fontanesi@ied.unipr.it

Marco Carnevale, Università degli Studi di Pavia, Dipartimento di Ingegneria Industriale e dell'Informazione, Via A. Ferrata 5, 27100 Pavia, Italy; Email: marco.carnevale@unipv.it; ORCID 0000-0001-6044-8323

aerospace, mould and die, energy, and machine tools building, each having specific requirements to be met [2]. If on the one hand flexibility is necessary to allow the machining of single complex work piece shapes with weights up to a few tons, on the other hand the machine accuracy has to remain no greater than micrometers. The above-mentioned characteristics, apparently in contrast, are usually faced with two different error elimination approaches: error avoidance and error compensation [3]. The former consists in deleting all the error sources during design, manufacturing and assembly stages, whereas the latter is aimed at correcting the errors that a machine commits [4-6].

Improvements in the error avoidance approach are strongly limited by the existing technologies and by the cost factor [7, 8], and consequently error compensation has become an important research topic in the field of high-precision machine tools. Precision in the mentioned CNC machine tools is mainly affected by geometric and thermal deformation errors, which are responsible for more than 60% of the total machining error [9]. They do not require a real-time correction because they are static or quasi-static errors and they are usually compensated by thorough but expensive calibration procedures, allowing the acquisition of the volumetric error of the machine.

This well-founded approach presents however some criticalities. The demanding calibration procedures require many resources and are a stumbling block in collecting measurement data [10-11], so that compensation tables remain generally static and not up-to-date. Temporal drifts due to wear and tear, for example, are overlooked. Moreover, error values are affected by a substantial variation with loading conditions (i.e. mass of the work piece, position of its center of gravity, etc.) as well as with environmental factors (i.e. temperature in the room, spatial gradients, humidity, etc.), but error parameters for compensation purposes are measured in a given environmental temperature and with unloaded machine, and compensation is applied on the application of the rigid body model.

As a consequence, in parts having size greater than one meter, the daily variation of ambient temperature (± 7 °C) gives raise to ± 0.3 mm errors due to temperature stabilization and thermal expansion; a work piece load of several tons is responsible for angular errors of ± 4 10-5 rad, i.e. ± 0.1 mm for a 2.5 m axis length; the stabilization of foundations in the first months can be measured in tenths of millimeters and gives a structural loop variation of ± 0.1 mm. The simultaneous combination of these factors strongly affects the machine tool accuracy, but the specific

influence of each factor is difficult to identify. In fact, the error sources have incidence on different time scales [12,13] (e.g. the load accounts for the entire duration of the processing, a large temperature variation can take days to stabilize) and their effects are profoundly different from a physical point of view (e.g. load generates bending, whereas different temperature gradients are responsible for thermal expansion). For all the above reasons, the effects of these non-comparable physical dimensions cannot be added beforehand.

In most cases applications described in literature are focused only on one specific aspect of the machine. This seems to be a critical aspect, since some works just consider the compensation of thermal errors [9, 15], others focus only on the speed of a predictive and compensative algorithm (without considering the data it can treat) and others only implement software for better errors measurement [16, 17]. Improve machine error compensation by applying software methods which consider the entirety of the factors is still an ongoing goal.

Many recent developments go in the direction of using of Neural Networks (NNs) [18-21]. Their functioning allows the continuous observation of the different parameters affecting the accuracy of the machine, providing a result which is the sum of all the effects. They do allow a real-time adaptation of the machine control, based on continuously monitored data, but this is obtained as a result of a black approach that cannot separate the effect of the different sources of error and does not allow to isolate the contribution of individual causes or their evolution over time.

Another criticality emerging from many literature applications is the lack of a complete management of collect data [15, 21-23]. Even if many measurements are properly carried out from a metrological point of view (i.e. measurements repeatability, model for the volumetric error calculation, etc.), a precise map of the machine history has still to be implemented. Obviously many recent industrial developments go in the direction of digitalization and are developing integrated solutions [24]. General purpose platform must anyhow be integrated to error compensation systems. The most interesting and innovative applications are only used in fields different from strict machining systems [25]. Within the illustrated context, this paper proposes the development of a self-learning system based on a support vector machine kernel and a fuzzy logic solver, whose first approach was presented at Euspen 2011 [26]. The system is able to manage and analyze a large amount of data, gathered firstly from complete calibration procedures, then from low-order recalibrations, embedded metrological systems, finished part measurements, and environmental sensors. The system captures and evaluates the production performance of the machine tool, and then improves them through the prediction of the possible errors that a machining process will present under new operating conditions, calculating error compensation values which can adapt to it.

The paper is organized as follows: section 2 describes the methods and algorithms applied for the compensations of the quasi-static errors, section 3 deals with the structure of the self-learning system: data acquisition and data processing are commented, as well as the way errors are predicted. Finally, section 4 describes the results on the 5-axis boring machine

considered in the present analysis, and conclusions are drawn in section 5.

II. APPLIED METHODS FOR QUASI-STATIC ERROR COMPENSATION

A. Error parameters and modelling

The performance of a machine tool is related to its ability to produce precise components and to get the required dimension of the work piece, and therefore to position in an accurate way the tool tip. This accuracy is affected by different sources of error, usually classified into four categories [4, 5]: geometric, kinematic, thermal and cutting-force induced errors. Geometric and kinematic errors are related to changes in the geometry of the machine components part of the machine structural loop, and they are caused by dimensional inaccuracies and relative motion between components. Thermal errors are caused by differing heat sources like machining, cutting process, environment, cooling systems, operators and thermal memory, which are all responsible for dimensional modifications as an effect of the expansion coefficient of the components. Finally, cutting force-induced errors depend on the dynamics of the machine; vibrations affect the force loop and therefore the geometric accuracy. Other error sources which are not part of the previous classes can be due to tool wear and errors in fixture, control software and, rather common, motion control [27].

Geometric and thermal errors can be defined as quasi-static errors, i.e. errors varying slowly in time and related to the machine structure. They usually account for approximately 60% of the total machine error, and are mainly of compensational nature. On the other hand, dynamic forces are limited to the cutting process of the machine and account only for a 10% of the overall error. For this reasons, significant improvements can be introduced through modelling and compensation strategies aimed at static and quasi-static errors.

The above-mentioned errors affect the volumetric accuracy of the machine, which is the ability to produce accurate 3D shapes. It can be considered as the synthesis of the effects of imperfect geometry and dimensions of the machine elements, thermal distortion and stresses in the structural loop, as well as distortions of the structural loop due to the weight of work pieces and components. The volumetric accuracy of the machine tool is modelled, according to the ISO 230-1 standard, by considering the positioning errors arising in the relative motion between the component carrying the cutting tool and the component carrying the work piece, during operation under no-load or in quasi static conditions. However, compensation of machine tools must deal with geometric errors depending on thermal deformation and load effects. If geometric errors due to both of these causes combine, it can be hard to discern their individual contribution on the volumetric accuracy. A suitable approach, adopted in this work to face such a circumstance, is to measure separately the dependence of the positioning errors on the external conditions, identifying first the effects due to thermal deformation under no loading conditions, and then the effect of deformations due to external loads.

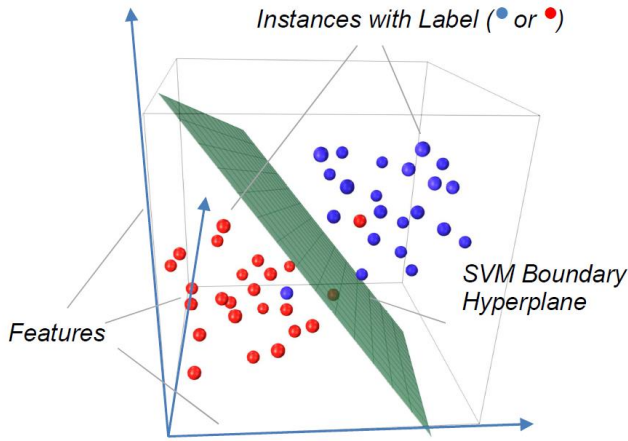

Fig. 1: Example of a boundary hyperplane identified by SVM.

When these errors are small enough, they can be identified separately and then superimposed to evaluate the volumetric accuracy. Geometric errors are considered in terms of both positioning errors and orientation errors of the axes of motion. The functional point of a moving component can be affected by three translational error motions, the first one along the direction of the nominal motion (linear positioning error motion) and the other two along two directions orthogonal to this main direction (straightness error motion).

When a moving component is commanded to move along a nominal straight-line trajectory, also three unwanted rotational movements around the three orthogonal directions are considered: one around the axis of motion (roll) and one around each of the two axes square to the axis of motion (tilt).

For an axis moving horizontally, tilts are defined as yaw (rotation around the vertical axis) and pitch (rotation around the remaining axis). A last error considered in 4 the modelling is the squareness error between two axes of linear motion. Totally, for a 3-axis machine tool, the considered errors are therefore 21.

B. Self-learning system methodology

The storage of a great quantity of measurements representing the geometric errors of the machine under different operating conditions constitutes the knowledge basis feeding the self-learning core. Data coming from sensors and artefacts can be complete or partial, but the amount of such data is in any case large. The self-learning system implemented is primarily based on a data mining procedure, consisting in the use of automated techniques to discover previously undetected relationships between data items [20] and to generate predictions: the actual operating conditions (in terms of loading conditions, environmental temperature, etc.) are classified into the collected historical data, so that a similar condition can be identified and errors for compensation purposes can be calculated.

In the proposed application the database contains all the measured error values referring to specific positions of the machine volume (where the measurement took place) and each one is associated to the specific operating conditions. The self-learning system has to define clusters in the data set, classify the actual condition in each of them (i.e. similarity analysis), and consequently infer the error values for compensation.

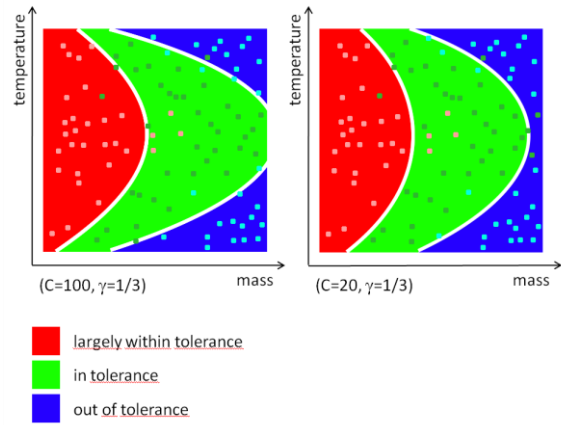

Fig. 2: Effect of the penalty parameter C on the results of SVM classification [26]

C. Similarity analysis

The similarity analysis has the goal of selecting the information within the database that is similar to the current operating condition. This is done through a Support Vector Machine (SVM), a supervised learning method applicable to non-linear models. Its working principle starts from a set of training data which are n-dimensional vectors (each dimension is called feature, x_i) with an associated target value (label, y_i). This data ($x_i; y_i$) is projected in a larger vector space and, based on this, SVM can produce an inferred function (model), which is called a classifier and describes the test data. The model is defined by calculating linear separating hyperplanes in vectorial space, which are the result of an optimization problem [28]:

$$\min_{w, b, \xi} \left(\frac{1}{2} w^T w + C \sum_{i=1}^l \xi_i \right) \quad (1)$$

subject to:

$$y_i (w^T \phi(x_i) + b) \geq 1 - \xi_i, | \quad (2)$$

$$\xi_i \geq 0$$

Training vectors x_i are mapped in a higher dimensional space by the function Φ . A good separation, intuitively, is achieved by the hyperplane with the largest distance to the nearest training data points of any class. The linear hyperplane with the maximal margin in a higher dimensional space is found by means of an Radial Basis Function kernel function (RBF):

$$K(x_i, x_j) = \exp(-\gamma \|x_i - x_j\|^2), \gamma > 0 \quad (3)$$

In the above equations, $C > 0$ (i.e. the penalty parameter of the error term) and γ are the two parameters that affect the kernel function. The best values for the parameters are defined through a grid search using cross-validation. In a nutshell, this function is able to define a number of sets in the test data, based on the label which is given as input. Fig. 1 and Fig. 2 report respectively an example of the boundary hyperplane identified by SVM,

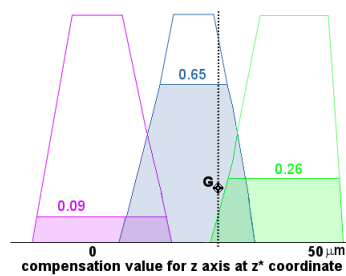

Fig. 3: Example of the application of fuzzy logic [26]

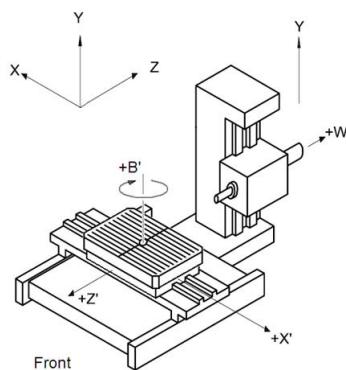

Fig. 4: Reference frame for the machine considered in this paper

and an example of classification with different values of the penalty parameter C.

Having defined this model, SVM can therefore predict the target values of the test data, which are vectors with the same dimension as the training data, but without a label. In this study, the dimensions of the training data set are the main characteristics of the load, the temperature-related information and other useful parameters. Each vector, i.e. each set of operating conditions, is labelled with the corresponding error compensation value. These vectors of dimension d_v are projected in a vector space of dimension $d > d_v$ so that the algorithm can calculate the linear separating hyperplanes, i.e. defining sets of machining situations which are similar. This model calculation generalises from the training data to unseen situations, allowing to predict group membership for new data instances. This means that it can classify new operating conditions that can occur and predict the label value, i.e. the error compensation value.

D. Inference

When the separating hyperplanes are clearly identified and indicate compact and convex sets of conditions, a good estimation of the values for error compensation could be inferred directly from the label of the belonging cluster. However, separations planes in general cannot exactly separate clusters, so that every single vector does not necessarily fall within the chosen class. This leads to a level of noise and a non-perfect correlation between input and output data. It is therefore necessary to adopt a further inference system, able to refine the estimation. A fuzzy logic inference system is adopted in this work, allowing a better granularity in setting tolerance ranges, to achieve a more accurate estimation, and to guarantee a learning process strictly supported by an operator. Following the Fuzzy

Control Language (FCL) defined by the standard IEC 61131, for each environmental parameter (input variable) a membership function is created. By applying inference rules which are implication methods combining inputs and outputs, it is possible to specify the influence of each single parameter on the error values, organized in quality classes. These membership functions are then combined and defuzzified by the inference engine to extract the best estimate for the error compensation value. An example of such a process is given in Fig. 3.

III. SELF-LEARNING SYSTEM STRUCTURE

A. Data acquisition

All data mining techniques base their strength on the gathering of great amounts of data. Consequently, the instrumentation for data acquisition requires the capacity to measure all the errors of the machine (6 for each axis), a setup capable of acquiring measurements both on the machine volume and in the surrounding space, and reliability from a metrological point of view (low resolution, correct use, independent measurements). The measurements come from different independent sources, and the acquired data are then modelled and stored in the self-learning system database. The available devices, aimed at the acquisition of geometric error, can be classified into:

- calibration systems;
- artefacts;
- on-machine sensors.

Each one contributes to the acquisition of complete or partial information to determine the volumetric error of the machine. Temperature sensors permit the quasi-continuous measurement of the thermal behaviour.

A calibrated laser interferometer is the tool typically used for machine calibration, permitting an effective but time-consuming measurement of angular, linear and straightness error motion; it is used also for a full error assessment under different loading conditions. Inclinometers with differential measurements are the most common tool for machine tool levelling (measurement of EAX, EAZ, ECX, ECZ, EAY, ECY, EAW, ECW, see Fig. 4 for the definition of the reference frame of the adopted machine). They are usually used for rapid and partial measurements, but they can also be used for a full error assessment of the machine.

Calibrated artefacts also allow a full error assessment. On the machine, a touch trigger probe is available, and it is used together with a 3D reference ball beam and a 3-spheres squareness reference artefact. Also a self-centering probe can be used together with a 3D long reference beam. These systems allow the measurement of a full range of geometric features and can extrapolate information of error motion of the machine. Measurement systems based on the use of calibrated artefacts is also used to measure changes of the error and for a quasi-continuous control through on-machine installations of the artefacts as reference structures. On-machine calibrated 3D reference artefacts made of carbon fiber like ball-bars or tetrahedrons deduce low order changes of correctable errors of machine motion. They are stable in length, straightness and twist.

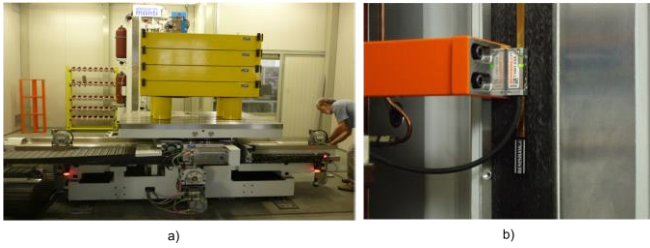

Fig. 5: a) Adoption of camera sensors to measure roll, pitch, yaw, straightness and errors of position of the X-motion; b) On-machine sensors installed for a quasi-continuous monitoring of linear positioning errors

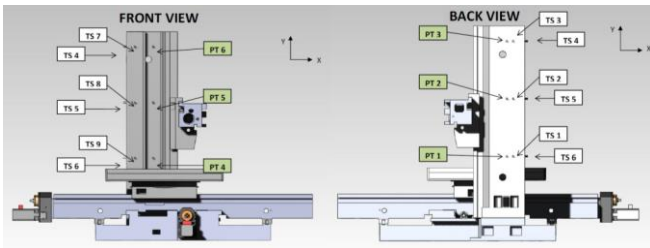

Fig. 6: Layout of temperature sensors: front and side views

Used with a camera sensor (see Fig. 5a) they allow the measurement of roll, pitch, yaw, straightness and errors of position of the X-motion.

On-machine sensors are installed for a quasi-continuous monitoring of machine errors. Invariant scales made of a special pultruded carbon fiber substrate provide a redundant measurement of linear positioning errors depending on their installation point (see Fig. 5b).

Besides these on-machine sensors, other traditional sensors like linear positioning transducers have been adopted. When stabilized for thermal influence they can measure linear error motion and, with differential measurements, can provide information on the pitch error motion of an axis. The last important measurement system is devoted to control the thermal behavior of the test chamber. Thermometers are distributed around the machine column to identify the environmental temperature and, taking into account the differences among them, they can also measure the temperature gradient in the area. Fig. 6 shows the front and side view of the machine column, with the positioning of the temperature sensors.

B. Data processing

A self-learning supervisor interfaces all the measurement systems, processes all the acquired data and stores them in a database. A scheme of the Internal Functions is reported in Fig. 7.

Data coming from measurement devices (sensor data, probe data, CN data, temperature data) are acquired through communication channels specifically developed and then processed. In fact, error measurements strictly depend on the hardware configuration that is controlled by the self learning system. Computational models are then required to obtain structured information shared with all the Self Learning Core (SLC) modules. To keep the system independent, these specific computation models are extension points, in order to allow specific development in case of hardware modifications. Once computed, measurement data are linked

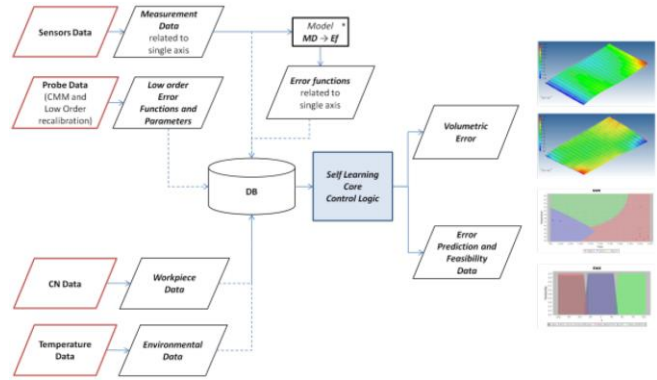

Fig. 7: Scheme of the Internal Functions of the Self-Learning Core

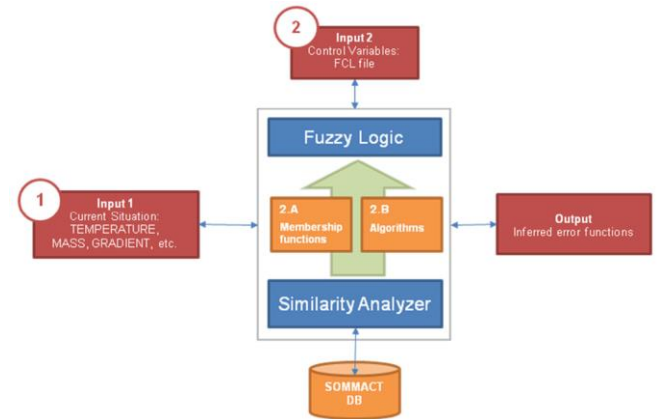

Fig. 8: Schematic overview of the process

with environmental temperature and work piece information obtained from the NC. Each single measurement is described through an error tag, an axis target, and a state of the kinematic chain. Data gathered in the database, being the knowledge basis for the SLC, are used as training data for the SVM algorithm. The quantity of reliable data added to the system database determines its capacity to predict error values. Using such a system in a shop floor with a vast number of machines of the same type allows a larger knowledge extraction. This can be useful, for example, to improve preventive maintenance, thus giving advantages which are not only limited to the mere machine accuracy improvement.

Once the experience database is created, the self-learning system can receive as input the definition of the current operating condition, then a prediction of the error values can be inferred. Although the system is extensible, only the most influential parameters are taken into consideration in the present analysis: work piece mass, average environmental temperature and gradients. The system is preliminary tested with a test data set test: without knowing the label, based on all the algorithms and steps previously described, the algorithm has to classify it in one of the clusters defined during the training phase.

C. Process overview and error prediction

Fig. 8 reports a schematic overview of the process: test data referring to the actual working session let the self-learning processing start. The system performs a coherent data selection inside the DB,



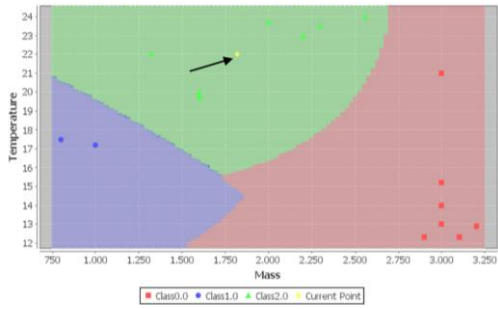

Fig. 9: Clusters obtained through the support vector machine

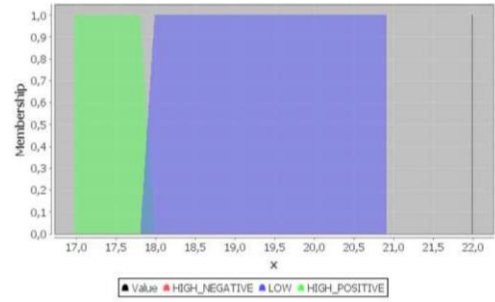

Fig. 12: Membership function: temperature

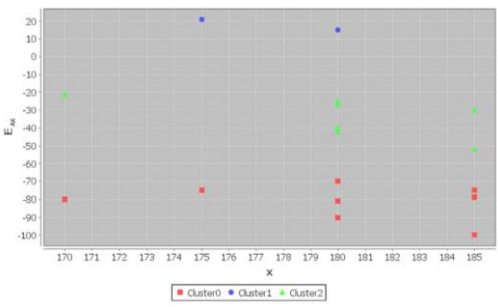

Fig. 10: Clustering ordered results

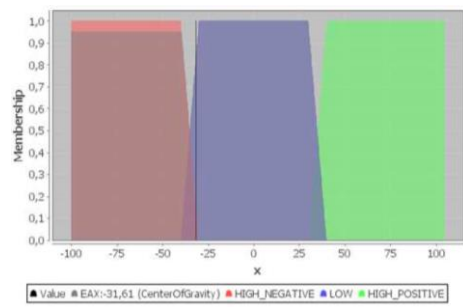

Fig. 13: Membership function: defuzzification of EAX error

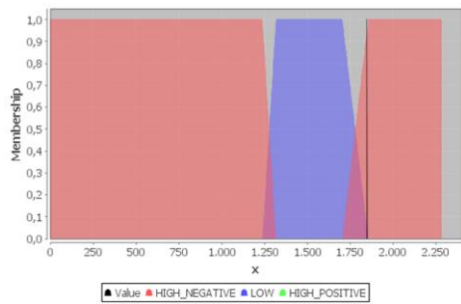

Fig. 11: Membership function: mass



Fig. 14: Inclinometers used to measure roll and pitch

considering the same measurement types, referring to the same state of the kinematic chain and to the same axis target. This data subset becomes the input for the algorithms for similarity analysis.

The selected points are clustered depending on the error value, like in the example of Fig. 9, and then mapped in a space defined by environmental variables (Fig. 10), with reference to which the SVM calculates the highest margin separating hyperplanes and classifies the current working condition. In the latter figure the current acquisition is marked with a yellow dot and highlighted with an arrow.

The set of error points of the selected cluster, i.e. cluster number 2 in the reported example, eventually becomes the input for the inference system. The external conditions associated to each point are used to create the membership functions in the fuzzy logic procedure. The external conditions of the current acquisition are then used to define the degrees of membership, which activate the inference rules. The results are combined through a proper accumulation method, i.e. the calculation of the centroid of the figure (see Fig. 11-13). The result of the inference process is the predicted error value for the specific error type, in the specified position of the working volume. Cycling the process in each point of the machine volume allows one to define the volumetric error.

IV. VALIDATION RESULT

A. Data taken into consideration

The first step of the validation consisted in the acquisition of data corresponding to different operating conditions, to understand the behavior of errors and to check the predictive capacity of the system. A 5-axis high precision boring machine has been used as a demonstrator. The machine was fully functional in an industrial shop floor, but used under controlled environmental conditions, being positioned inside a thermostated chamber and installed on a special concrete foundation.

The errors taken into account were the angular roll and pitch deviations relative to the two independent X and Z axis (i.e. the horizontal movement of the work piece table) measured with electronic inclinometers. A first one was positioned on the machine table and the other one on the column, as reported in Fig. 14. The intentional variation of the operating conditions was limited to work piece mass (five different loading conditions) and temperature setup point inside the chamber (three different setups), to focus on the parameters mainly affecting the geometric error. The combination of the variations resulted in fifteen different measurement procedures.

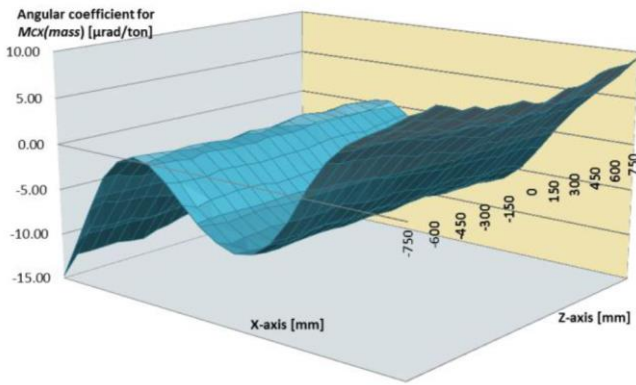

Fig. 15: Representation of the slope of X-axis pitch deviation in function of the workpiece mass for an X-Z plane of the machine

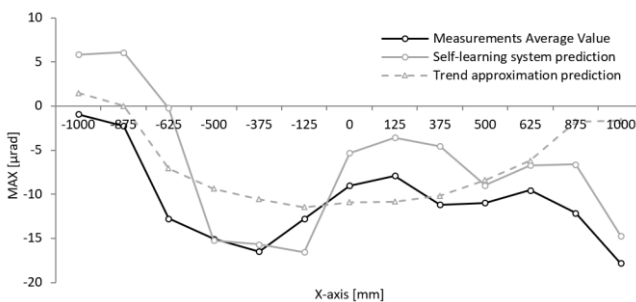

Fig. 16: Prediction results for 4000 kg load (Z-axis position is zero)

For each one, the geometric errors were measured in each point of a 21x21 grid covering the whole axes length on an horizontal section of the machine working volume (i.e. Y-axis fixed).

B. Measurement analysis

Data collection allowed the creation of a database where each measurement is associated to the particular operating condition of the machine. This information is necessary for the learning phase of the self-learning system, and is also exploited for a theoretical characterization of the influence of the different error sources on the machine. The analysis of error data corresponding to different positions of the machine volume shows that the influence of some external parameters can be described with simple linear relationships (e.g. adding 1 ton of load, angular deviations vary of 7-8 μrad), but more in depth considerations indicate that the angular coefficient of this linear law depends on the position of the axes. Fig. 15 shows the angular coefficients of the linear function defining the dependence of the X-axis pitch deviation on the workpiece mass, when varying the axis position in the XZ horizontal plane of the machine. This angular coefficient has a non-linear trend when changing the x-axis position, although this trend is repeatable when changing the position along the Z-axis. Also the average temperature in the room is found to have a relevant influence; in fact, a 10°C variation causes variations of up to 100 μrad for angular errors, that stabilize not less than 12 hours after the temperature variation has ended. This information is useful to characterize the machine behaviour, but cannot be used for error compensation

purposes since it is closely linked to the particular configuration of the machine.

The self-learning system based on a Support Vector Machine kernel allows to overcome these limitations. It actually selects historical measurements performed in conditions similar to the current one, based on load and temperature parameters (further dimensions could be taken into account in a second step). After the measurement selection, it is possible to predict an adequate error compensation value for the current conditions.

The results of the algorithm are compared with on field measurements performed in the same operating conditions, considering an average of the point by point deviation between the two functions. The response is quite variable depending on the case under consideration, due to the small amount of historical measurements and the non-homogeneous distribution of measurements over the variation range of the parameters.

However, predictions for non-general conditions (e.g. 2 tons load, Fig. 16) show a small deviation (5-10 μrad) and can recognize the trend of the error function better than a trend approximation approach, based on the particular relationship found through the data analysis.

V. CONCLUSIONS

This paper presents the results of an innovative approach for error compensation in a high precision machine tool. The system, based on artificial intelligence techniques, is capable of managing a great amount of data to predict the machine behavior. It can deal with complex systems and its architecture makes it operative regardless of the machine tool type, the number of axes and the kinematic configuration.

ACKNOWLEDGMENT

The research leading to these results has received funding from the European Community's Seventh Framework Programme (FP7/2007-2013) under grant agreement No. CF-FP 2291122-2.

REFERENCES

1. M. Silvestri, M. Confalonieri, A. Ferrario, A. Bettoni, M. Floris, M. Banfi, "Use of Laser Scanners in Machine Tools to Implement Freeform Parts Machining and Quality Control", *Smart Innovation, Systems and Technologies*, Volume 54, 2016, Pages 527-536, International Workshop on Neural Networks, WIRN 2015; Vietri sul Mare; Italy; doi: 10.1007/978-3-319-33747-0_52
2. Silvestri, M.; Cucchi, T.; Confalonieri, M., "An Innovative Electric Ship Steering System: Analysis and Implementation", *International Journal of Mechanical and Production Engineering Research and Development*, Vol. 9, Issue 4, Aug 2019, 415-424, doi: 10.24247/ijmperdaug201941
3. M. Confalonieri, A. Ferrario, and M. Silvestri, "Calibration and on-board positioning correction system for micro-edm machines", in *Euspen 18th International Conference & Exhibition*, pp. 1315-1317, 2018. <https://www.euspen.eu/knowledge-base/ICE18153.pdf>
4. R. Ramesh, M. Mannan, and A. Poo, "Error compensation in machine tools - a review. Part i: geometric cutting-force induced and fixture dependent errors", *International Journal of Machine Tools and Manufacture*, vol. 40, pp. 1235-1256, 2000
5. R. Ramesh, M. Mannan, and A. Poo, "Error compensation in machine tools - a review. Part ii: thermal errors", *International Journal of Machine Tools and Manufacture*, vol. 40, pp. 1257-1284, 2000.
6. H. Giberti, L. Sbaglia, M. Silvestri, "Mechatronic Design for an Extrusion-Based Additive Manufacturing Machine", *Machines*

- 2017, 5, 29. doi:10.3390/machines5040029
7. G. Avventuroso, R. Foresti, et Al., "Production paradigms for additive manufacturing systems: A simulation-based analysis", *2017 ICE/ITMC*, Madeira Island, Portugal, 2017, pp. 973-981, doi: 10.1109/ICE.2017.8279987
 8. M. Silvestri, "Dynamics modeling and optimization of a wrapper flow pack mechanism", *International Journal of Recent Technology and Engineering*, vol. 8(2), pp. 2707-2713, 2019, doi:10.35940/ijrte.B2906.078219
 9. W. Feng, Z. Li, Q. Gu, and J. Yang, "Thermally induced positioning error modelling and compensation based on thermal characteristic analysis", *International Journal of Machine Tools and Manufacture*, vol. 93, pp. 26-36, 2015, doi:10.1016/j.ijmactools.2015.03.006
 10. G. Avventuroso, M. Silvestri, E. Morosini Frazzon, "Additive Manufacturing Plant for Large Scale Production of Medical Devices: A Simulation Study", *IFAC-PapersOnLine*, Volume 51, Issue 11, June 2018, pp. 1442-1447, ISSN: 2405-8963, doi: 10.1016/j.ifacol.2018.08.312
 11. C. Bergonzi, A. DiNatale, F. Zimetti, C. Marchi, A. Bianchera, F. Bernini, M. Silvestri, R. Bettini, and L. Elviri, "Study of 3d-printed chitosan scaffold features after different post-printing gelation processes", *Scientific Reports*, vol. 9, 2019, doi:10.1038/s41598-018-36613-8.
 12. Elviri, L., Bianchera et Al., "3D-Printed Polylactic Acid Supports for Enhanced Ionization Efficiency in Desorption Electrospray Mass Spectrometry Analysis of Liquid and Gel Samples", *Talanta* (155) pp. 321-328, doi: 10.1016/j.talanta.2016.05.010
 13. G. Avventuroso, M. Silvestri and P. Pedrazzoli, "A Networked Production System to Implement Virtual Enterprise and Product Lifecycle Information Loops", *IFAC-PapersOnLine*, Volume 50, Issue 1, July 2017, pp. 7964-7969, doi: 10.1016/j.ifacol.2017.08.902
 14. M. Silvestri, "Adaptive mechanisms for reconfigurable machines based on deformable cam", *International Journal of Mechanical and Production Engineering Research and Development*, vol. 9(4), pp. 609-622, 2019, doi:10.35940/ijrte.B2906.078219
 15. J.-H. Lee and S.-H. Yang, "Thermal error modeling of a horizontal machining center using fuzzy logic strategy", *Journal of Manufacturing Processes*, vol. 3(2), pp. 120-127, 2001.
 16. W. Zhu, Z. Wang, and K. Yamazaki, "Machine tool component error extraction and error compensation by incorporating statistical analysis", *International Journal of Machine Tools and Manufacture*, vol. 50, pp. 798-806, 2010.
 17. M. Silvestri, "Motion law assisted design to reduce the vibrational effect of controlled axes in automated machines", *International Journal of Recent Technology and Engineering*, vol. 8(2), pp. 3778-3783, 2019, doi:10.35940/ijrte.B3459.078219
 18. M. Yang and J. Lee, "Measurement and prediction of thermal errors of a cnc machining center using two spherical balls", *Journal of Materials Processing Technology*, vol. 75, pp. 180-189, 1998.
 19. M.-W. Cho, G.-H. Kim, T.-I. Seo, Y.-C. Hong, and H. H. Cheng, "Integrated machining error compensation method using omm data and modified pnn algorithm", *International Journal of Machine Tools and Manufacture*, vol. 46, pp. 1417-1427, 2006.
 20. K. K. Tan, S. N. Huang, S. Y. Lim, Y. P. Leow, and H. C. Liaw, "Geometrical error modeling and compensation using neural networks", *IEEE Transactions on Systems, Man, and Cybernetics Part C: Applications and Reviews*, vol. 6, pp. 797-809, 2006.
 21. J. M. Fines and A. Agah, "Machine tool positioning error compensation using artificial neural networks", *Engineering Applications of Artificial Intelligence*, vol. 21, pp. 1013-1026, 2008.
 22. S. Ding, X. Huang, C. Yu, and W. Wang, "Actual inverse kinematics for position-independent and position-dependent geometric error compensation of five-axis machine tools", *International Journal of Machine Tools and Manufacture*, vol. 111, pp. 55-62, 2016, doi:10.1016/j.ijmactools.2016.10.001
 23. G. E. D'Errico, "Fuzzy control systems with application to machining processes", *Journal of Materials Processing Technology*, vol. 109, pp. 38-43, 2001.
 24. L. Sbaglia, H. Giberti, et Al., "The Cyber-Physical Systems within the industry 4.0 framework", *Advances in Italian Mechanism Science – Mechanisms and Machine Science*, Volume 68, 2019, Pages 415-423, 2019, doi: 10.1007/978-3-030-03320-0_45
 25. G. Ahci, R. Jagielski, Y. A. Sekercioglu, and B. Shirinzadeh, "Prediction of geometric errors of robot manipulators with particle swarm optimisation method", *Robotics and Autonomous Systems*, vol. 54, pp. 956-966, 2006
 26. M. Silvestri, P. Pedrazzoli, C. Boër, D. Rovere, "Compensating High Precision Positioning Machine Tools by a Self Learning Capable Controller", *Proceedings of the 11th International Conference of EUSPEN*, Como, 23-27 Maggio 2011, pp. 121-124
 27. M. Silvestri, M. Confalonieri, A. Ferrario, "Piezoelectric Actuators for Micro Positioning Stages in Automated Machines: Experimental Characterization of Open Loop Implementations", *FME Transactions* (2017) 45, 331-338, doi:10.5937/fmet1703331S
 28. B. Boser, I. Guyon, and V. Vapnik, "A training algorithm for optimal margin classifiers", *COLT '92 Proceedings of the fifth annual workshop on Computational learning theory*, 1992, doi:10.1145/130385.130401.

AUTHORS PROFILE



Marco Silvestri worked in automation and industrial vision fields as developer and responsible for validating automated machinery. He's been head of R&D of the equipment manufacturer for meat industry Tecnomec srl. Since 2002 he is researcher and assistant professor at University of Parma, where he's been scientific manager of the postgraduate course on Automated Machines for the Life Sciences Industries. Since 2011 he is docent-researcher at the University of Applied Science of Southern Switzerland. He is chief scientist of several research and technology transfer projects in the fields of 3D printing of food and biomedical products, in-line metrology for high precision manufacturing, advanced diagnostic systems and non-conventional controls for homogenizers.



in-line metrology.

Stefano Fontanesi holds a MSEng in Mechanical Engineer and is a PhD candidate at Parma University. He worked as research assistant in SUPSI (Switzerland) and as production engineer at STM spa. His research interests lie primarily on the field of automated production systems, self learning systems and



Marco Carnevale is Associate Professor of Applied Mechanics at Università di Pavia, Dipartimento di Ingegneria Industriale e dell'Informazione (Industrial and Computer Science), where is now mainly involved in Robotics and Automation of Mechanical Systems. His research activity, previously started at Politecnico di Milano, Dipartimento di Meccanica, is also focused on Railway Dynamics, with particular reference to the topics of Condition Based Monitoring and Maintenance, Pantograph and Catenary Dynamic Interaction and Active Control. He is author of more than 40 publications on International Journals and Proceedings of International Conferences.

